

MODEL R5VI-ICA

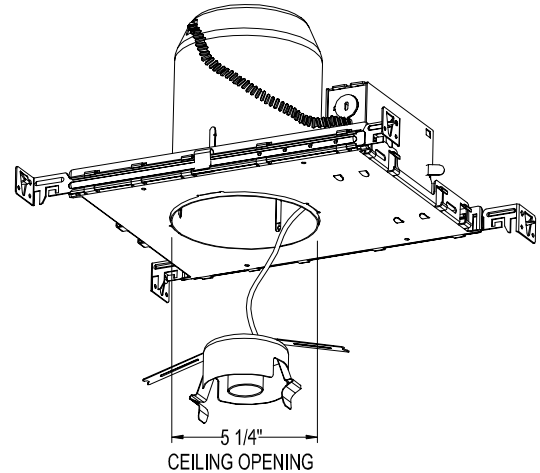

Ordering information

R5VI	-	-	-	ICA	
Series	-	Housing Depth	-	Housing Type	Options
R5VI Recessed 5 inch Vertical Incandescent	-	S - Shallow Depth Blank - Normal Depth	-	R - Remodel Housing Blank – New Construction	ICA - Insulation Contact & Air Tight

Product Features

Application: New construction housing suitable for insulation contact. Complies with requirements for Washington State Energy Code (WESC) for air tight housings (when installed as instructed with option gasket kit "RGK"). Maximum 1 3/4 inch ceiling thickness.

J Box: Junction box is accessible from above or below the ceiling. Supplied with eight standard knockouts and four integral Romex® clamps. Spring loaded door, for easy access to wiring. Approved for through branch wiring.

Mounting: Supplied with hanger bars adjustable to 25" Bars have score lines and can be cut to accommodate 12" joist spans. Bars have notches for easy installation on T-bars. Hanger bars mount on all four sides.

Material: 20 gauge galvanized steel. Ceramic/nickel-plated socket.



















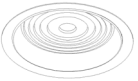

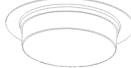
Listing

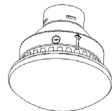
UL & CUL listed. Suitable for damp locations.

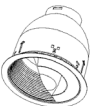
W.A.C. reserves the right to change details that do not affect overall function and performance.

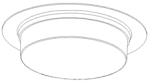
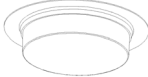

MODEL R5VI-ICA

<p>R5VT-21-□□ Finishes: SC, SG Lamp: A19 100W, PAR38 100W</p>		<p>R5VT-22-□□ Finishes: SC, SG Lamp: A19 75W PAR30 75W</p>		<p>R5VT-24-□□* Finishes: SC, SG Lamp: A19 100W PAR38 90W</p>	
<p>R5VT-26-□□ Finishes: WT Lamp: A19 52W, PAR38 75W BR40 85W</p>		<p>R5VT-27-□□ Finishes: SBK, SC, SG, WT Lamp: A19 60W, PAR30 75W PAR38 75W</p>		<p>R5VT-29-□□ Finishes: BK, WT Lamp: A19 40W PAR30 75W PAR38 75W</p>	
<p>R5VT-32-□□ Finishes: BK, WT Lamp: A19 40W PAR30 75W PAR38 75W</p>		<p>R5VT-33-□□ Finishes: SA, WT Lamp: A19 40W, PAR30 50W</p>		<p>R5VT-34-□□ Finishes: WT Lamp: A19 60W</p>	
<p>R5VT-35-□□ Finishes: WT Lamp: A19 60W</p>		<p>R5VT-36P-□□ Finishes: WT Lamp: A19 40W</p>		<p>R5VT-36G-□□ Finishes: WT Lamp: A19 40W</p>	
<p>R5VT-37-□□ Finishes: WT Lamp: A19 40W</p>		<p>R5VT-38-□□ Finishes: WT Lamp: A19 40W</p>		<p>R5VT-39-□□ Finishes: WT Lamp: A19 40W</p>	
<p>R5VT-58-□□ Finishes: BK, WT Lamp: PAR30 50W</p>		<p>R5VT-59-□□ Finishes: BK, WT Lamp: PAR30 50W</p>		<p>R5VT-60-S-□□ Finishes: SC, SG Lamp: A19 60W, PAR30 75W</p>	
<p>R5VT-61-S-□□ Finishes: WT Lamp: A19 60W, PAR30 75W</p>		<p>R5VT-62-S-□□ Finishes: BK, WT Lamp: A19 60W, PAR30 75W</p>		<p>R5VT-63P-S-□□ Finishes: WT Lamp: A19 40W</p>	
<p>R5VT-63G-S-□□ Finishes: WT Lamp: A19 40W</p>		<p>R5VT-64-S-□□ Finishes: WT Lamp: A19 40W</p>		<p>R5VT-66-S-□□ Finishes: WT Lamp: PAR30 75W</p>	

Finish Key: BK-Black, SA-Satin Aluminum, SBK-Specular Black, SC-Specular Clear, SG-Specular Gold, WT-White
 All trims are white, finish choices refer to baffle or reflector color.
 *Trim finish is the same as the reflector.

