

The Quality Of Our Sofas

The high quality and competitive price of Italsofa Furniture is a result of a careful analysis when purchasing raw materials directly from their places of origin, and strict quality control of the

various production phases in our plants as we construct the frame, process the leather and blend and mold the foam to create the comfortable seating Italsofa is known for.

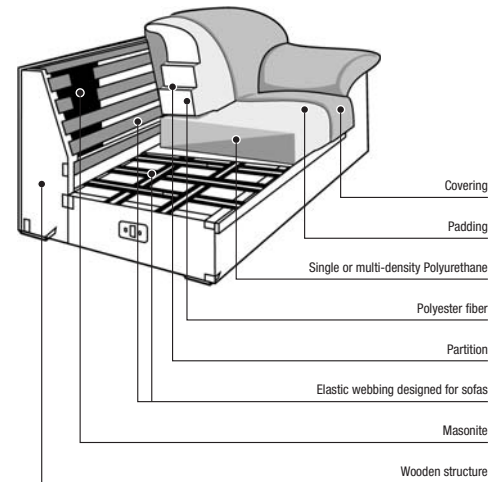

The Frame

SPECIFICATIONS

All materials used to construct the frame guarantee the solidity of our sofas, they are rigorously tested in the Italsofa laboratory to ensure long-lasting performance in any climate.

The choice of wood, the main material used in the frame construction, complies with the strictest international regulations regarding chemical content and environmental responsibility. The frame is designed and engineered by Italsofa technicians using highly sophisticated electronic techniques capable of identifying the most appropriate building material for each application. All new models are subjected to further laboratory testing, under exacting load conditions and in

compliance with the major international standards before being manufactured. Extremely durable, patented industrial-strength straps complete the frame – together with the padding, they contribute to the distinctive comfort of our sofas.

CAUTION

- Do not jump or throw yourself onto the sofa
- Do not sit on the arms and/or the back.
- Do not move the sofa by pushing it. The correct way to move the sofa is by lifting it from the base.

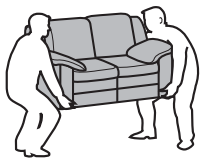

The Padding

SPECIFICATIONS

Two types of padding are used, depending on the shape and the style of each design, i.e.:

- Polyurethane
- Polyester fiber down,

Italsofa expanded **polyurethane foam** is ecological; it does not contain Freon or other expanding agents. The presence of the open cells, visible to the naked eye, ensures a higher level of durable comfort.

The fiber fillings are very thin polyester filaments that provide a high degree of softness. These fiber fillings, selected to pad the seating, back and armrests, are used to provide a very soft level of comfort for all the parts of the body that come in contact with the furniture.

MAINTENANCE

The Italsofa padding material does not require any specific type of maintenance except for the kind associated with the normal care of the sofa. In particular, if you purchase sofas that have a fiber filling or down padding, it will be necessary to model or 'dress' them to ensure they return to their initial look, which will have altered during transit.

CAUTION

- During the first three months of use, polyurethane foam padding tends to soften then should permanently stabilize.
- This settling may also create slight folds on the covering, which is a completely normal characteristic of the product.



Before modelling

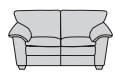

After modelling



The Feet

The feet, being an integral part of the sofa, are accurately designed and produced using specific materials to ensure that the best aesthetic result is achieved. To prevent the feet from being damaged during transit, they must be installed at the final destination point only.

- Please read the instructions detailed in the attached document before mounting the feet.
- Tighten the feet firmly.
- Avoid removing the sofa packaging using pointed or sharp objects that may damage the covering (e.g. scissors or knives)
- Spread the cellophane sheet on the floor, lower the sofa so that the

rear back panel rests against the floor, then mount/install the feet.

- The sofa must be lifted and turned to return it to an upright position, but avoid using the feet as a lever to prevent any damage.

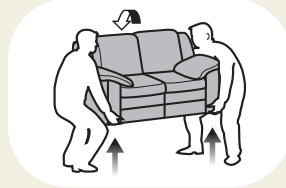

- Avoid moving the sofa by dragging or lifting by the armrests: the correct way to move the sofa is by lifting it from the base.

The Covering

The following covering materials may be used on our sofas:

- Leather
- Microfibre
- Innovative materials

More stitches may be used when the sofa is leather covered (Fig. A), compared to the same model with microfibre covering (Fig. B)

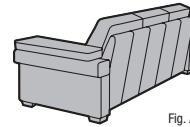

Fig. A

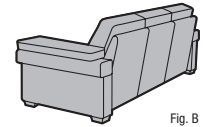

Fig. B

Leather Covering

Natural leather is a noble and resistant material, which becomes more valuable over time. Its transpiration properties make it warm in the winter and cool in the summer, and its flexibility allows it to mold perfectly to the body's shape. Characteristics such as healed scars, wrinkles, insect bites, breaks, veining, and variations in grain and color are natural features of hides that give them their value and natural character. For this reason, the hides that our craftsmen select one by one undergo tanning processes

that do not alter their natural characteristics, but allow them to become fine leather perfectly suited for use in your home.

On some parts of the sofa, and sometimes over the entire surface, one can use the split leather, the underlying part of the raw hide. Split leather is also a natural product which makes the cost of the sofa more competitive without compromising quality. Following are some natural characteristics you will find on your leather sofa.



Low Graining



Closed Scar



Closed Scars



Grain Difference



Wrinkle



Insect Bites



Veining



Differences In Tone

CLEANING THE LEATHERS

- Periodically dust using a clean, dry and non-abrasive white cloth.

- For dry dirt: brush delicately using a brush with soft bristles or use a vacuum cleaner at the medium suction power setting, using the soft brush attachment. Take care to avoid rubbing the accessory directly against covering.

- For stains caused by substances soluble in water (e.g. soft drinks, coffee, tea, milk, jam): rapidly remove the liquid from the surface using a white, non-abrasive cloth (or absorbent paper). Then rub delicately working from the outside of the stain towards the center, using a clean, damp cloth soaked in water. Do not soak the leather surface, and dry immediately using a dry cloth. Do not dry the leather in direct sunlight or with a hair dryer.

- For stains caused by greasy substances (e.g. oil, ketchup, mayonnaise, chocolate): remove the substance delicately from the surface using absorbent paper, applying minimal pressure so as to prevent the dirt from entering the pores of the leather. Use a clean cloth, soaked in a very diluted solution of neutral soap, rubbing delicately, working from the outside towards the center of the stain.

- Dry immediately using a clean cloth. Use water and colorless, mild soap only

- If you purchase a new sofa with a covering that is meant to be the same color as a sofa that you already own, it is possible that you may note slight variations in shades of color between the two. This is a result of the unique character of each hide.

Microfibre Covering

Our sofas are covered in the best microfibers bought from the leading producers in the world. All articles are subjected to demanding quality tests such as the Martindale test, which determines their resistance to wear. Please follow the instructions on the care and maintenance of microfiber according to the covering category for your sofa (A, B, C or D), which you will find on the back of this booklet or under the sofa, if the covering is fixed.

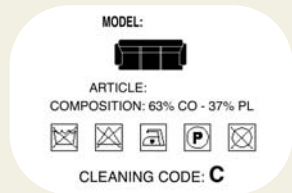

CLEANING MICROFIBERS

Remove stains from microfiber coverings according to the type of stain:

Liquors

Dab with absorbent paper or a white, non-abrasive cloth and then remove the stain. Wash using only colorless, mild soapsuds obtained by shaking the container vigorously. If the stain persists, then remove the stain using only 10% denatured

alcohol diluted in lukewarm water. Dry immediately with warm air using a hair dryer. Direct the jet of warm air from the outside working towards the center of the damp area.

Soft drinks/wine

Dab with absorbent paper or a white, non-abrasive cloth to remove the stain. If the stain persists, remove it using only a solution of one part vinegar to one part lukewarm water. Then wash using only colorless, neutral soapsuds obtained by shaking the container vigorously. Finally dab the soapsuds with a cloth dampened with water. Dry immediately with warm air using a hair dryer. Direct the jet of warm air from the outside working towards the center of the damp area.

Coffee/Tea

Dab with absorbent paper or a white, non-abrasive cloth and then remove the stain. If the stain persists, wash using only colorless, mild soapsuds, obtained by shaking the container vigorously. Then remove the stain using only a solution of 10% ammonia diluted in luke-warm water. Dry immediately with warm air using a hair dryer. Direct the jet of warm air from the outside working towards the center of the damp area.

Beer

Dab with absorbent paper or a white, non-abrasive cloth. If the stain persists, remove it using only warm water (max 40°C / 104°F) diluted with 3% denatured alcohol in lukewarm water. Dry immediately with warm air using a hair dryer. Direct the jet of warm air from the outside working towards the center of the damp area.

Oil

Absorb the stain as much as possible using absorbent paper or a white, non-abrasive cloth. If the stain persists, wash it using only colorless, mild soapsuds, obtained by shaking the container vigorously. Absorb the stain as much as possible using absorbent paper. Remove the stain using a white, non-abrasive cloth dampened only with perchloroethylene, if the stain persists. Absorb as much of the stain as possible with absorbent paper. Dry immediately with warm air using a hair dryer. Direct the jet of warm air from the outside working towards the center of the damp area.

CAUTION

- Position the sofa at least 50cm (20 inches) from sources of heat such as heaters or radiators.
- Avoid exposing the sofa to direct sunlight or to powerful lamps to ensure the color of the covering remains bright.

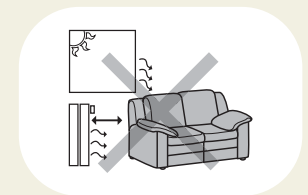

- To remove dust, brush delicately using a brush with soft bristles or use a vacuum cleaner with the medium power output setting using the most suitable accessory supplied with the cleaner and taking care not to rub the accessory directly against the covering.
- To maintain the aesthetic appearance it is advisable to treat each stain immediately before it becomes excessively absorbed: this will avoid prolonged or abrasive treatments being required.

The Reclining Functions

- If it is necessary to use solvents, avoid applying the solvents directly onto the stain. Pour the solvent onto a clean cloth: each treatment should first be tested on a concealed area of the sofa covering.
- Clean the stain using a circular movement, working from the outside towards the center.
- Always take care to rub each stain delicately.
- If you purchase a new sofa with a covering that is an identical article and/ or has the same color as a sofa that you already own, it is possible that you may note variations in shades of color between the two.

ARMCHAIRS AND SOFAS WITH A MANUAL MECHANISM

Armchairs and sofas with a reclining mechanism offer the possibility of changing the inclination of the back, positioning the legs horizontally and altering the seating position.

If you have purchased an armchair or a sofa with the sliding function (Zero Wall), you will also have the possibility of reclining the armchair or sofa without having to move the upholstered furniture away from the wall.

In fact, the seat and back move forward during extension thanks to a special mechanism.

If you have purchased an armchair with swivel action

(rocking chair), in addition to the reclining function you will also have the rocking action and can turn the armchair about its vertical axis.

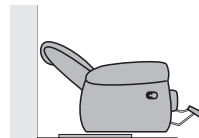
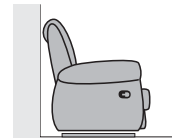

USE

The ways of using the reclining functions vary depending on the individual design.

Reclining with handle

The mechanism extension is achieved by using the handle positioned on the outside of the armrest, pulling this handle allows the footrest to release and extend. The armchair is designed to recline fully by exerting pressure on the seat-back. The armchair is returned to its upright position by moving the seat-back forward and

moving the footrest back to the initial position by exerting pressure with the legs. If you have purchased a sofa with a central reclining seat, the opening handle is positioned between the cushions

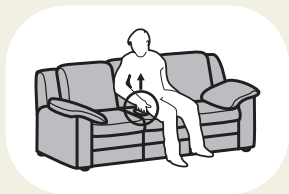

Armchair with rotating function

The rotating function, available for armchairs only, is always active. It is sufficient to rest your feet on the ground and exert sideways pressure to turn.

Armchair with rocking chair function

The rocking function is automatically activated by the lever that unlocks the reclining mechanism or by moving the lever positioned behind the armchair to the left. The rocking chair function is locked by moving the lever positioned

behind the armchair to the right and moving the backrest slightly at the same time to allow the locking bayonet to be correctly inserted in position.

CAUTION

- Before using our product with incorporated mechanism, check whether a plastic strap restrains the mechanism. If the strap is still on, it must be cut and removed.

- Do not use solvents to clean the metal parts of the mechanism: a damp cloth is sufficient.

- Do not allow children to play with the mechanism.

- The mechanism must only be used when the person is correctly seated.

- If the mechanism squeaks when in operation, lightly lubricate the springs, the hinges and all the moving joints using normal spray-on lubricants available on the market.

- Do not sit on the front edge of the armchairs that have the rocking function, otherwise the armchair could touch the ground and cause damage.

Bed Functions

BEDSPRINGS

If necessary a number of our sofa designs can be used as comfortable beds. Two types of bedsprings are available: "Double Folding" and "Triple Folding". The type of spring depends on the depth of the sofa. Double folding bedsprings are equipped with a variable inclination headrest.



- Lower the supporting foot positioned below the mattress, accompanying it to the ground.

USE

Double Folding Bedsprings

- Remove the seat cushions. If a leather strip covers the upper edge of the bed spring, this strip must be folded forward to protect the sofa covering.

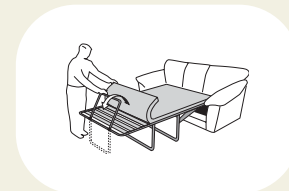

- Raise the bedspring by gripping the central handle and pulling outwards while folding the bedspring support bar on the floor.

- Lift the headrest raising it up to the first notch. Lifting it over the notch and releasing it slowly back to its initial position lowers the headrest.



- Grip the second supporting bar in the center of the bar, raise and accompany the bar until it touches the floor.

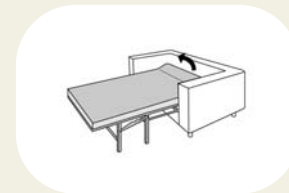

- Repeating the same operations in reverse order closes the bed. If there is a leather strip, re-position it after the operations to close the bedspring have been completed.

Modular Components

Triple Folding Bed Springs

- Remove the seat cushions. If a leather strip covers the upper edge of the bedspring, this strip must be folded forward to protect the sofa covering.
- Raise the bedspring by gripping the central handle and pulling outwards.



- Grip the first supporting bar at the center of the bar, raise and accompany the bar until it touches the floor.



- Repeat the operation for the second supporting bar.



- Repeating the same operations in reverse order closes the bed. If there is a leather strip, re-position it after the operations to close the bedspring have been completed.

CAUTION

- Before using our products that incorporate a mechanism, it is necessary to cut the safety tab that restrains the mechanism.
- Remove the polystyrene insert, which prevents oscillations of the bedspring during transit.
- Do not use solvents to clean the metal parts: a dry cloth is sufficient.
- Do not allow children to play with the mechanism.
- Remove the bed sheets and blankets before closing the bedspring.
- Avoid sitting on the edge at the foot of the bedspring.
- Do not sit or stand on the head of the bedspring.

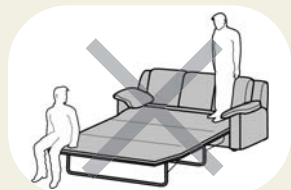

PRODUCT FEATURES

This product line enables your sofa to be freely composed according to the space available. The following illustration shows an example of an arrangement obtained using only a few components: sofa with left armrest, corner piece, sofa without armrest and chaise longue.

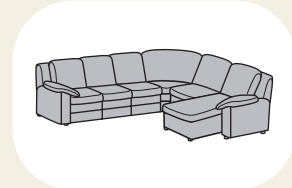

INSTRUCTIONS FOR DOWEL TYPE ASSEMBLY

The connection system consists of a dowel to be fitted on the left-side component, which must be inserted in the drilled plate of the right-side component.

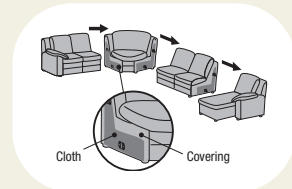

Assembly

Align the component parts, ensuring that the dowel is inserted in the hook-up components on the right side and position the component parts close together until they are firmly hooked.

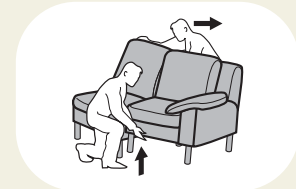
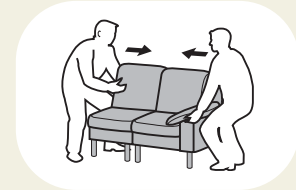

Disassembly

Raise and separate the left-side component until it is completely free.



Limited 10-year Warranty

CAUTION

Do not lift and move the sofa while it is still hooked.

- The dowels have to be fitted on the right side component in several versions: in these cases follow the instructions detailed in the illustrating leaflet attached to the sofa.
- Each individual piece making

up a complete version is lined on the matching sidepieces facing the cover and not with the relative finish lining.

- When fixed and reclining versions are combined, a non-alignment of approximately three centimeters will be noted in the rear/ lower part of the sectional sofa due to technical design reasons.

ATTENTION!

Removing or mishandling the components of your furniture (or product) could cause damage and/ or injury to persons, animals and things.

No liability is accepted for events of this nature. Please read and keep the instruction manual with your furniture (or product).

Italsofa sofas and armchairs are all covered by a specific warranty, subject to this certificate. We therefore kindly ask you to read it carefully. This Warranty applies only to furniture utilised under normal household use and conditions.

Terms and duration

Any request for assistance under this warranty shall be made through the retailer from whom the purchase was made and shall require a dated proof of purchase.

The request of service shall be made promptly following the discovery of any alleged defect, no later than:

- thirty (30) days after the defect could have been discovered through the exercise of reasonable diligence by the Purchaser;
- fourteen (14) days after purchase for visible defects claimed at the time of delivery;

Your Italsofa product is covered, under normal use and starting from the date of purchase:

- for a period of ten (10) years for the internal frame construction;

- for a period of two (2) years for the cushioning, mattresses and sleeper mechanisms, stitching, manual and/or electric mechanisms, the suspension system (webbing), exposed wood trim and fabric coverings. After the first year from date of purchase, this warranty covers only parts and materials necessary for repair and does not cover labour;

- for a period of two (2) years against the tearing and splitting of the leather. After the first year from date of purchase, this warranty covers only parts and materials necessary for repair and does not cover labour. Italsofa guarantes that its furniture coverings are 100% genuine leather.

This warranty does not cover any accidental or consequential damage, including loss of time, usage or money. In no event shall the responsibility of Italsofa exceed the purchase price of the product or its replacement. If identical materials are not available at time of repair, Italsofa reserves the right to substitute materials of equal quality and value.

Exclusions and exceptions

This warranty specifically excludes claims for:

- commercial, contract, rental trade, institutional or other non-residential use;
- wrinkling or natural markings from injuries to the skin, variations in grain, or color variations resulting from the natural features of the leather. These are proof that only genuine leather has been used;
- cracking or peeling of the leather;
- damage caused by burns, cuts, animals, or other forms of abuse;
- damage due to improper cleaning, abuse or negligence;
- damage resulting from exposure of the leather to direct sunlight, extreme heat, bright lights or similar conditions and, any resulting discoloration;
- damage by corrosive materials, such as acids or solvents, dyes, inks, paints, human or animal bodily fluids;
- damage resulting from improper use, abuse or acts of God;

- damage incurred during the handling and transportation of the product;

- floor samples sales or sales made on "as is" basis;

- furniture repaired by service centres not endorsed by Italsofa;

- interpretation of defects caused by misinformation or negligence in disclosure by the retailer.

Furthermore, the warranty does not cover:

- damages to leather or fabric coverings due to the application of chemicals, cleaners or conditioners not endorsed by Italsofa;

- claims for products that have been tampered with or where the label that carries the ID number has been removed from the base of the sofa;

- the purchaser, if he transfers this warranty to third parties or moves from the original delivery address;

- packaging or transportation costs to and from the manufacturer, retailer or other repair point as determined by Italsofa;

What to do if assistance is required

When applying for assistance under this warranty, the purchaser should contact the retailer from whom the Italsofa product was purchased and submit the claim complete with the product identification number, as well as the photographs that document the fault or flaw claimed. Please remember that removing the label from the base of the sofa invalidates this warranty.

The retailer will forward the claim to Italsofa having personally verified that the product presents manufacturing defects. Italsofa will thereafter repair or replace the product or part thereof at its own discretion, following further verification of manufacturing or finishing

defects relating to the frame, leather, mechanisms, mattresses or cushions by its own representative.

We advise the purchaser that softening of cushioning should be expected as a result of the normal use and is not to be confused with loss of resiliency due to defects in constructions or materials.

This warranty covers repairs exclusively relating to materials or manufacturing considered defective.

Italsofa provides no other guarantees, except as provided herein whether expressed or implied, unless otherwise provided by applicable laws. This warranty gives purchaser specific rights which may vary from State to State.