

**MODEL NO.
SS-2960**

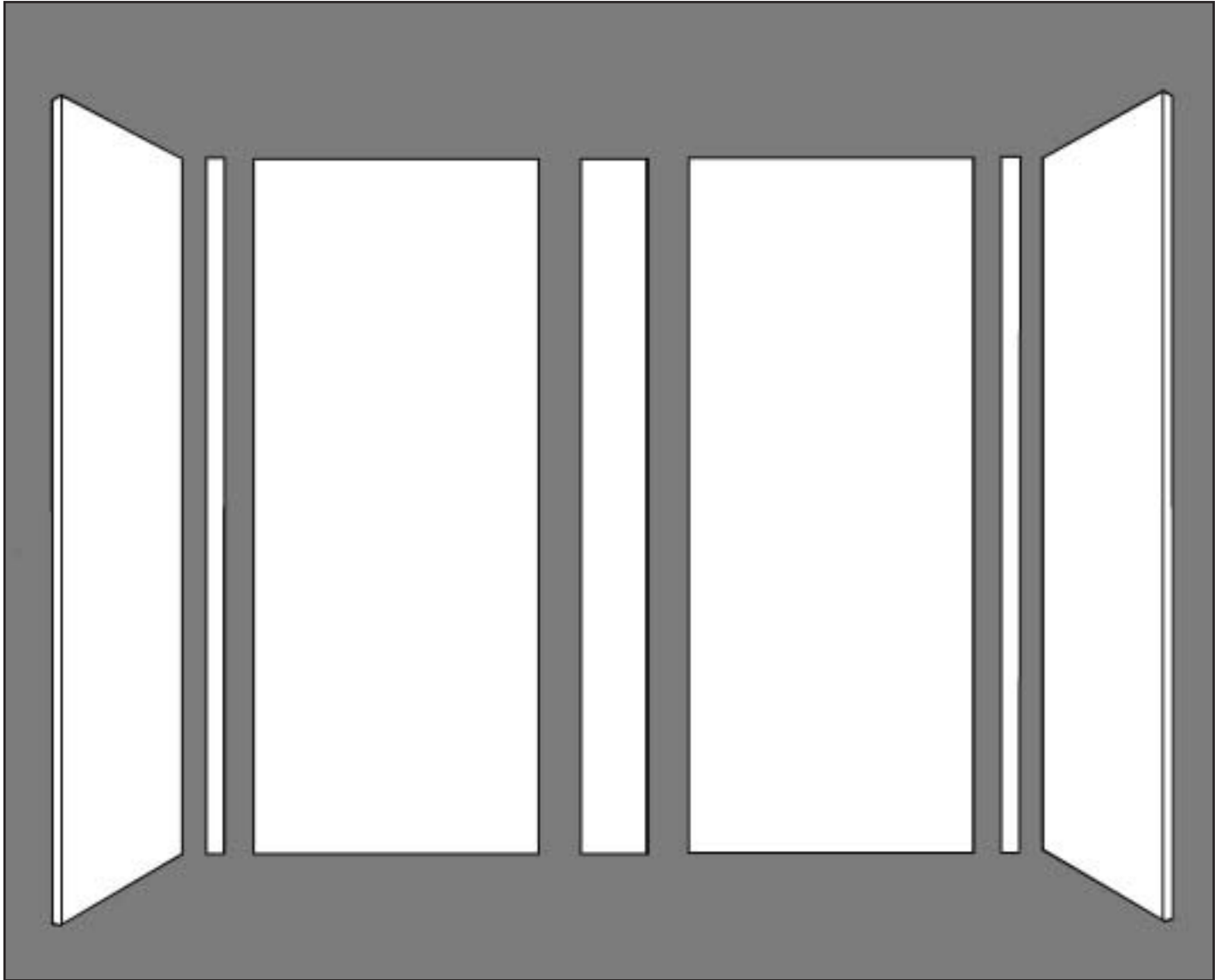

**OWNER'S
MANUAL**

BATHTUB WALL PANELS



INSTALLATION • CARE AND CLEANING



CAUTION:
Read ALL instructions carefully
BEFORE starting your installation.

*Save this manual for
future reference*



BATHTUB WALL PANELS

Model SS-2960 Designed To Fit 30" x 60" Bathtub

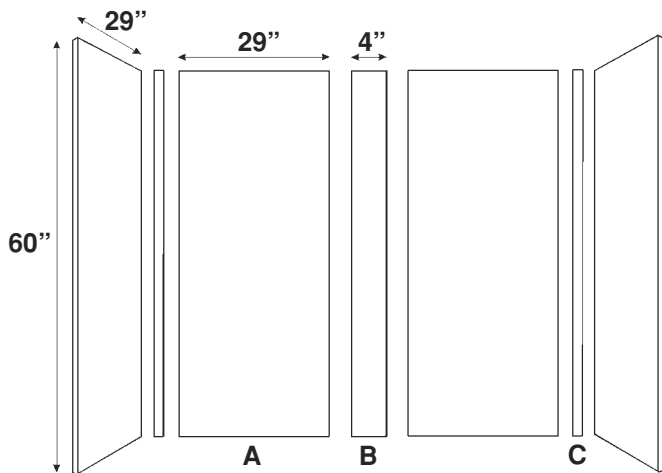

INCLUDED IN CARTON

- A** Four flat panels
- B** One batten trim strip
- C** Two corner moldings

IMPORTANT

Measure the width of the back wall. If it measures more than 61", the SS-2960 cannot be installed.

In addition, if your bath area is more than 29" deep, the side panels will not come flush to the front edge of the tub. For bath areas 32" deep, the TK-6072 trim kit will be required. You must follow the procedures, as directed, in the Swanstone trim kit installation instructions. It will be necessary to trim the batten trim strip or the optional DSP-2 Soap Dish Panel accessory in order to apply the TK-6072 trim kit.

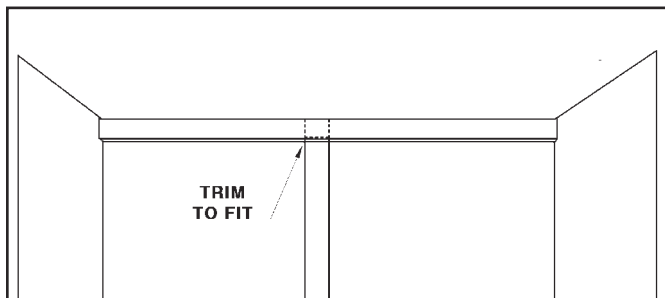

FILLER BOARD

Measure the height of the tiles from the tub ledge upward. If the tiles measure less than 59-5/8", it is necessary to install a filler board. The filler board must equal the thickness of the tile. Usually, 1/4" masonite or similar material is adequate.

For best results, extend the filler board from the top tile edge to the ceiling.

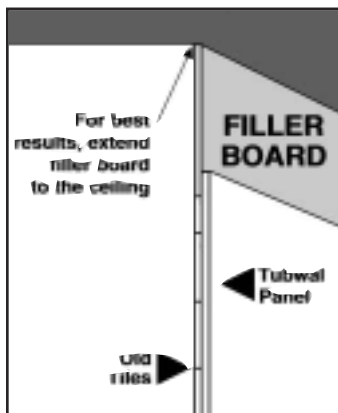

Swanstone Tubwall Accessories

- A. TK-6072** Trim Kit adds an elegant edge detail to bath area.
- B. RF-6475** Mechanical Mount Corner Soap Dishes 6" x 4-3/4" easily mount over brackets.
- C. AS-1075** Recessed Accessory Shelf installs vertically or horizontally.
- D. SS-29** Installation Kit has four tubes of adhesive, one tube of caulk, one foam spacer and one roll of pressure sensitive tape
- E. SS-7211** Corner Soap Dish offers greater convenience when two are installed.
- F. DSP-2** Soap Dish Panel 6-1/2" x 60" has two molded in soap dishes.

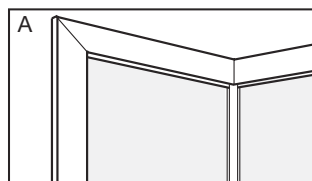
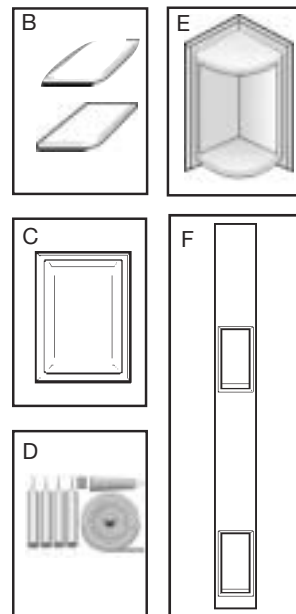

TOOLS REQUIRED TO INSTALL

The only tools needed are: saber saw, drill, ruler, caulking gun, four tubes of adhesive, one tube of caulk, pressure sensitive double stick tape, a foam spacer and whatever tools needed to remove faucet handles.

DO NOT NAIL PANELS TO TUBWALLS

The SS-2960 panels mount to walls with adhesive and pressure sensitive tape.

READ ALL INSTALLATION INSTRUCTIONS (INCLUDING ANY ACCESSORIES) BEFORE STARTING.

INSTALLATION PROCEDURE:

Allow panels to adjust to room temperature (65° to 90°) for at least 6 hours.

Next, turn off hot and cold water supply, remove faucet handles, escutcheons, filler spouts and any fittings mounted to the wall that will be covered ie. towel bars, soap dishes, etc.

Use hammer and chisel to remove objects cemented to walls. Old ceramic tiles, if solidly adhered to walls, may be covered with this kit and need not be removed.

Loose ceramic tiles must be removed and sub walls sanded smooth.

Front edge ceramic tiles may be reset for appearance only. Remove soap film and all dirt from wall surface using detergent. Wipe dry. Wall surface must be dry before panels can be applied.

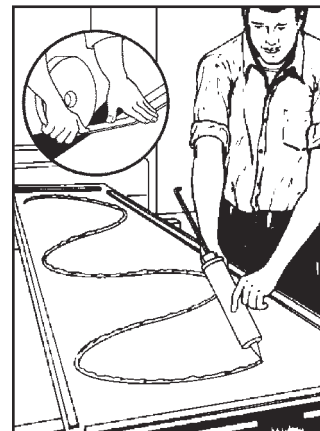

IMPORTANT

Trial fit before you begin.

1. BACK WALL

Select any one of the four flat panels for positioning on either the right or left side of the back wall. Apply the pressure sensitive tape (see SS-29 installation kit) 1" from each edge. Apply adhesive as shown above. Keep adhesive at least one inch from the tape.

WALL SURFACE PREPARATION RECOMMENDATIONS FOR SWANSTONE TUBWALL AND SHOWERWAL UNITS

When installing over SHEETROCK/GREENBOARD/WOOD:

- A) Surface must be dry, smooth and free of any dust, soap scum or any other contaminants. Wipe wall surface with a damp cloth.
- B) For maximum adhesion, the area where the double-faced tape adheres to the wall surface should be sealed with a primer (Bin-Seal or all purpose enamel paint).
- C) After primer/sealer is completely dry, complete the installation following the installation instruction sheet.

When installing over PLASTER:

- A) Surface must be dry, smooth and free of any dust, soap scum or any other contaminants. Wipe wall surface with a damp cloth.
- B) The area where the double-faced tape adheres to the wall surface (textured/swirled finish must be sanded smooth) should be sealed with a primer (BinSeal or all purpose enamel paint).
- C) After the primer/sealer is completely dry, complete the installation following the installation instruction sheet.

When installing over CEMENT/CONCRETE:

- A) Surface must be dry, smooth and free of any dust, soap scum or any other contaminants. Wipe wall surface with a damp cloth.
- B) The complete area should be sealed with two coats of primer (Bin-Seal or all purpose enamel paint).
- C) After primer/sealer is completely dry, complete the installation following the installation instruction sheet.

When installing over OLD TILE:

- A) Surface must be dry, smooth and free of any dust, soap scum or any other contaminants. Wipe wall surface with a damp cloth.

NOTE: CERAMIC: LOOSE TILE MUST BE REMOVED.

PLASTIC: ALL TILE MUST BE REMOVED.

- B) Complete the installation following the installation instruction sheet.

When installing over WALLPAPER:

- A) All wallpaper must be removed from the area to be covered. Surface must be dry, smooth and free of any dust, soap scum or any other contaminants. Wipe wall surface with a damp cloth.
- B) For maximum adhesion, the complete wall surface area to be covered by unit should be sealed with two coats of primer (Bin-Seal or all purpose enamel paint).
- C) After primer is completely dry, complete the installation following the installation instruction sheet.

When installing over MASONITE:

- A) Surface must be dry, smooth and free of any dust, soap scum or any other contaminants. Wipe wall surface with a damp cloth.
- B) Complete installation following the installation instruction sheet.

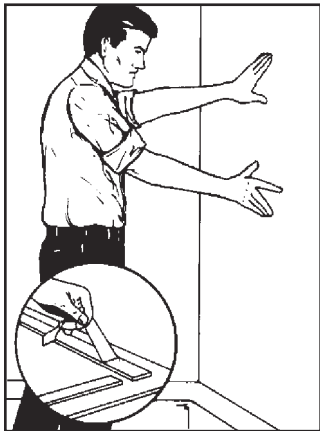

2. Remove the backing from the pressure sensitive tape. Grasp panel by the edges, carefully position to the right or left side of the back wall. Place panel edge into the corner and press firmly into place. Move hand pressure up and down and side-to-side, making sure all areas make firm contact to the wall. Repeat the above for the other panel installation.

NOTE

If panel trimming is required, (see step 3) do not apply tape until panel has been trimmed. This will ensure that the tape remains 1" from edge and is not damaged during the trimming.



3. IF TRIMMING IS REQUIRED

If the exposed area of the back wall for second panel installation is less than 29", trimming of the second wall panel will be required. Transfer measurements of exposed back wall onto the second panel. Since it is not necessary for the two back panels to butt flush at the center, trim the back wall panel edge that faces the center of the tub area. This seam will be covered with the 4" x 60" batten trim strip. Cut the wall panel from its back side with a saber saw. Lightly sand the cut edge with fine or medium sandpaper to remove any rough edges. Apply tape and adhesive as indicated in step one.

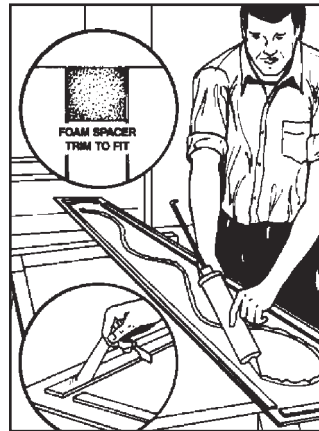

4. CENTER BATTEN STRIP

If a gap exists between the two back wall panels, place the foam spacer (see SS-29 installation kit page 2) 1/4" from the upper edge of the right and left panels. The foam spacer may be trimmed to fit. This spacer will aid in the caulking application to follow later.

Tip: Trial fit for center and lightly mark, in pencil, a center line on tub ledge and on center front of batten trim strip.

Apply tape 1" from panel edges and 1/8" bead of adhesive to the back of the batten trim strip, keeping the adhesive at least one inch from the tape and panel edges. Remove the backing from the pressure sensitive tape.



5. Carefully center the batten trim strip over the back wall panels (align your center marks) and press firmly into place from top to bottom making sure all areas are in solid contact with the wall panels.

(continued on back page)

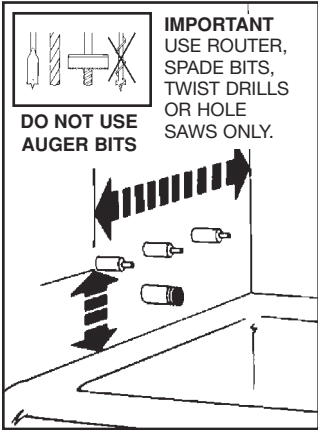

6. If the end of the tub has settled or the walls are out of plumb, it may be necessary to cut the bottom edge of a side panel(s) to achieve a level edge across the top from the adjoining back panel(s). Measure location of the plumbing outlets from the back wall forward and from the top tub ledge upward. Transfer these measurements to the side panel.



7. Cut holes 1/2" larger than the diameter of the pipes. Drill from the finished side of the panel. For best results place a scrap of wood beneath the hole to be made. This will ensure a clean cut.

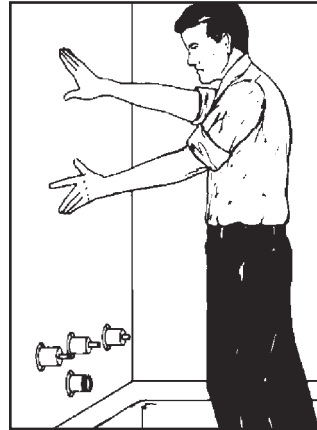

8. Trial fit each panel before proceeding. For an attractive installation, it is important that the top edges properly align.



9. Apply adhesive and tape as indicated in step one.

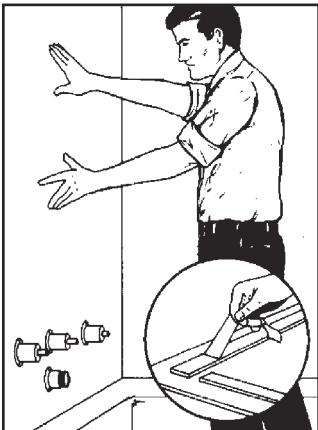

10. Remove the backing from the pressure sensitive tape. Place the appropriate panel edge carefully into the corner seam and press entire panel firmly to the wall. Move hand pressure up and down and side-to-side. Make sure all areas are in solid contact with the wall. Repeat the above for the opposite panel.

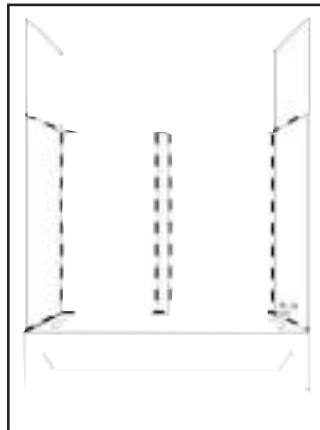

11. **CAULKING** Follow the instructions on the caulking tube and apply a bead of caulk along the bottom and top edge of the back and side walls. Also apply caulk to all vertical seams and edges.

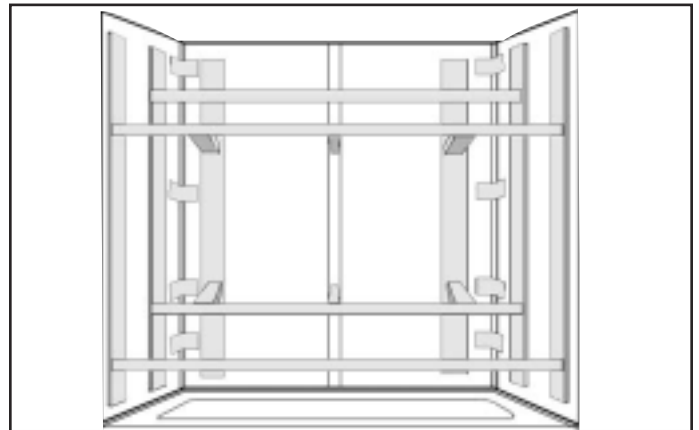

12. Trial fit the placement of the corner moldings and transfer the height measurement of the vertical seam to the corner molding. Trim corner moldings. Apply a 3/16" bead of adhesive in each corner seam. Press the corner moldings firmly into their appropriate corners. Immediately remove any excess adhesive with a damp cloth. Temporarily secure corner moldings to the back and side walls with masking tape. Allow adhesive to cure overnight.

NOTE

To promote contact until adhesive sets, use temporary bracing and allow adhesive to cure overnight. Temporary bracing may be constructed by wedging, as illustrated, lengths of 1 x 2s, 2 x 2s and 1 x 3s.

POSITIVELY NO HAMMERING OR NAILING IS TO BE DONE

CLEANING

Clean your Swanstone Bathtub panels as you would any other fine bath fixture, using normal household detergents and cleansers. Just wiping the wall surfaces quickly removes watermarks and residue. Occasional scrubbing with household abrasive cleansers maintains Swanstone's beautiful lustre.

REPAIRING

Use 400 grit sandpaper to remove scratches and gouges in the surface. A "Scotchbright pad" can be used to blend the repair into the surrounding area.