

IMPORTANT SAFETY INSTRUCTIONS

1. **Read all instructions - All the safety and operating instructions should be read carefully before this turbo hockey game is played.**
2. **Caution - This is not a toy and is intended for use by or under the supervision of adults. Adults should review safety guidelines with children to avoid possible risk of electric shock or other injuries.**
3. **Power sources - This hockey game should be operated only from 100-125V A.C., 50/60 cycle current as indicated on the identification label. If you are not sure of the type of power supply to your home, consult your appliance dealer or local power company.**
4. **Power cord protection - Power cord should be routed so that it is not likely to be walked on or pinched by items placed upon or against it. Pay particular attention to cords at plugs, convenience receptacles, and the point of exit from the game.**
5. **Overloading - Do not overload wall outlets and extension cords as this can result in a risk of fire or electric shock.**
6. **Object and liquid entry - Never push objects of any kind into this game through openings as they may touch dangerous voltage points or short-out parts which could result in a fire or electric shock. Never spill liquid of any kind on the game.**
7. **Ventilation - Openings in the game are provided for the exhaust air to create a cushion effect. The openings on the air blower are for the intake air. Keep clear of the air blower when it is on. Do not put hand or other objects near the intake openings. To ensure reliable operation of the game and protect it from overheating these openings must not be blocked or covered.**
8. **Damage requiring service - Unplug the game from the wall outlet. Do not attempt to service the blower yourself as opening or removing covers may expose you to dangerous voltage or other hazards. Refer servicing to qualified service personnel under the following conditions.**
 - A. When the power supply cord or plug is damaged.
 - B. If liquid has spilled, or objects have fallen into the blower.
 - C. When the air blower exhibits a distinct change in performance e.g. abnormal noise, this indicates a need for service.
9. **Grounding or Polarization - This game is equipped with a polarized alternating current line plug (a plug having one blade wider than the other). This plug will fit into the power outlet only one way. This is a safety feature. If you are unable to insert the plug fully into the outlet, try reversing the plug. If the plug should still fail to fit, contact your electrician to replace your obsolete outlet. Do not defeat the safety purpose of the polarized plug.**
10. **CAUTION - ELECTRICALLY OPERATED PRODUCT - Not recommended for children under 8 years of age. As with all electrical products, precautions should be observed during handling and use to reduce the risk of electric shock.**
11. **We recommend that the game be periodically examined for conditions that may result in the risk of fire, electrical shock, or injury to persons. In the event such conditions exist, the game should not be used until properly repaired.**

SAVE THESE INSTRUCTIONS

**WARNING: To Reduce The Risk Of Fire Or Electric Shock,
Do Not Use This Fan With Any Solid-State Speed Control Device**

MODEL # 34045 HG

Congratulations on owning a new Sportcraft Turbo Hockey game! We at Sportcraft hope you will have many hours of enjoyable use with this product.

 **WARNING:** Choking Hazard -- Toy contains small balls and/or small parts. Not for children under 3 years.

IMPORTANT!









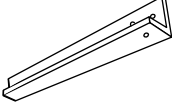
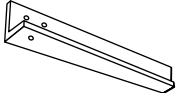

Please Keep Your Instructions in the storage pouch provided underneath your table! Your Model number (also located on the underside of the table) is necessary should you need to contact us. Before attempting assembly, please read through this instruction book to familiarize yourself with all the parts and assembly steps. We recommend that two adults assemble this game. Please refer to the Parts Identifier below and be sure that all parts have been included. Although we at Sportcraft are dedicated to giving our customers the best product possible, occasionally a part may be missing. If you are missing a part, you can access our website (www.sportcraft.com) 24 hrs. a day to place your order or to explore the latest product information. Or, if you have any questions, please call our customer service department at 1-800-526-0244 between the hours of 9:00 a.m. and 5:00 p.m. Eastern Standard Time.

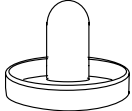
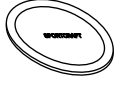

Do not return the game to the store. Please contact us first at our web site (www.sportcraft.com), at 1-800-526-0244, or fax your request to us at: 1-973-347-1541.

TOOLS REQUIRED FOR ASSEMBLY:

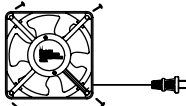
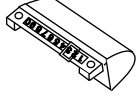
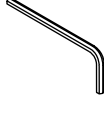
- Phillips and Slotted Head Screwdrivers (or Power Driver) - not included
- Allen Key - included

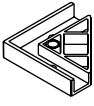
PARTS IDENTIFIER

<p>#1</p>  <p>RIGHT L-SHAPE LEG (2 EA) # 34091HG01</p>	<p>#2</p>  <p>LEFT L-SHAPE LEG (2 EA) # 34091HG02</p>	<p>#3</p>  <p>6 X 30MM ALLEN KEY BOLT (12 EA) # 34091HG03</p>	<p>#4</p>  <p>18MM FLAT WASHER (12 EA) # 27093SC11</p>	<p>#5</p>  <p>LEG LEVELER (4 EA) # 27093SC12</p>
<p>#6</p>  <p>3.5 X 30MM WOOD SCREW (4 EA) # 34061SC10</p>	<p>#7</p>  <p>3.5 X 12MM WOOD SCREW (4 EA + 16 PRE-INSTALLED) # 35093SC14</p>	<p>#8</p>  <p>PUSHER (RED) (2 EA) # 34091HG04</p>	<p>#9</p>  <p>ROUND PUCK (BLACK) (3 EA) # 27064SC52</p>	<p>#10 (PRE-INSTALLED)</p>  <p>APRON CORNER WITH SCREWS (BLACK) (4 EA) # 34091HG05</p>
<p>#11 (PRE-INSTALLED)</p>  <p>BLOWER WITH SCREWS (1 EA) # 34091HG06</p>	<p>#12</p>  <p>GOAL BOX W/ SLIDE SCORER (RED) (2 EA) # 34045HG01</p>	<p>#13</p>  <p>5MM ALLEN KEY (1 EA) # 34091HG07</p>	<p>#14 (PRE-INSTALLED)</p>  <p>NAME PLATE (1 EA) # 35005HG07</p>	<p>#15 (PRE-INSTALLED)</p>  <p>PLASTIC LEG CAP WITH SNAP RIVETS (4 EA) # 34091HG08</p>

<p>#16 (PRE-INSTALLED)</p>  <p>4 X 50MM BLOWER SCREW (4 EA) # 34091HG09</p>	<p>#17 (PRE-INSTALLED)</p>  <p>SNAP RIVETS (8 EA) # 34087HG11</p>
--	--

ASSEMBLY INSTRUCTIONS:
We recommend that two adults work together to assemble this game.

- 1) Open the carton of your new Turbo Hockey Game near where you will play. Select a clear level floor. This game requires at least two adults to assemble the table.
- 2) Remove all the contents from inside the carton and verify that you have all listed parts as shown on the Parts Identifier. We suggest that you use the bottom carton as a clean flat work area to protect the game. Carefully cut or tear the four carton corners so that the bottom is now your work area.

FIG. 1

- 3) Attach the Right (#1) and Left (#2) Legs to the table using three of the 6 x 30mm Allen Key Bolts (#3) and three of the 18mm Flat Washers (#4) per leg as shown in Fig. 1. Tighten using the Allen Key (#13).
- 4) Locate the four Leg Levelers (#5) and screw one into each leg. **NOTE:** Leg Levelers are optional, and if the game is to be used on a smooth floor, we recommend not installing them.

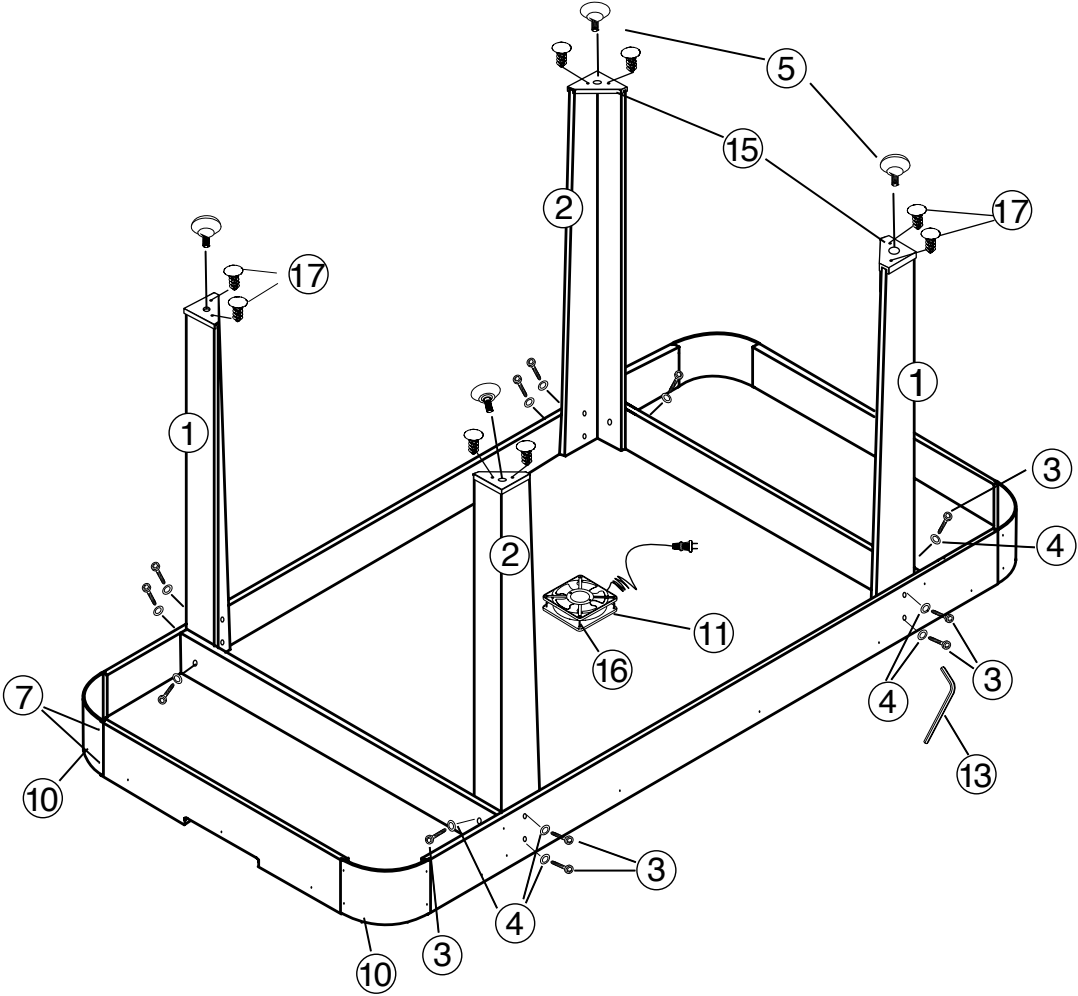

- 5) Lift the table assembly from the floor with two strong adults, turn it over, and set table on its legs in the location where you will play. Go back and make sure that all connections are tight.

CAUTION: Two strong adults are recommended to flip the table as shown.

1. Lift the table off the ground.
2. Turn the table over.
3. Place it on all four feet at the same time on the ground.

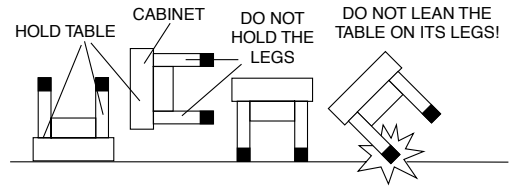
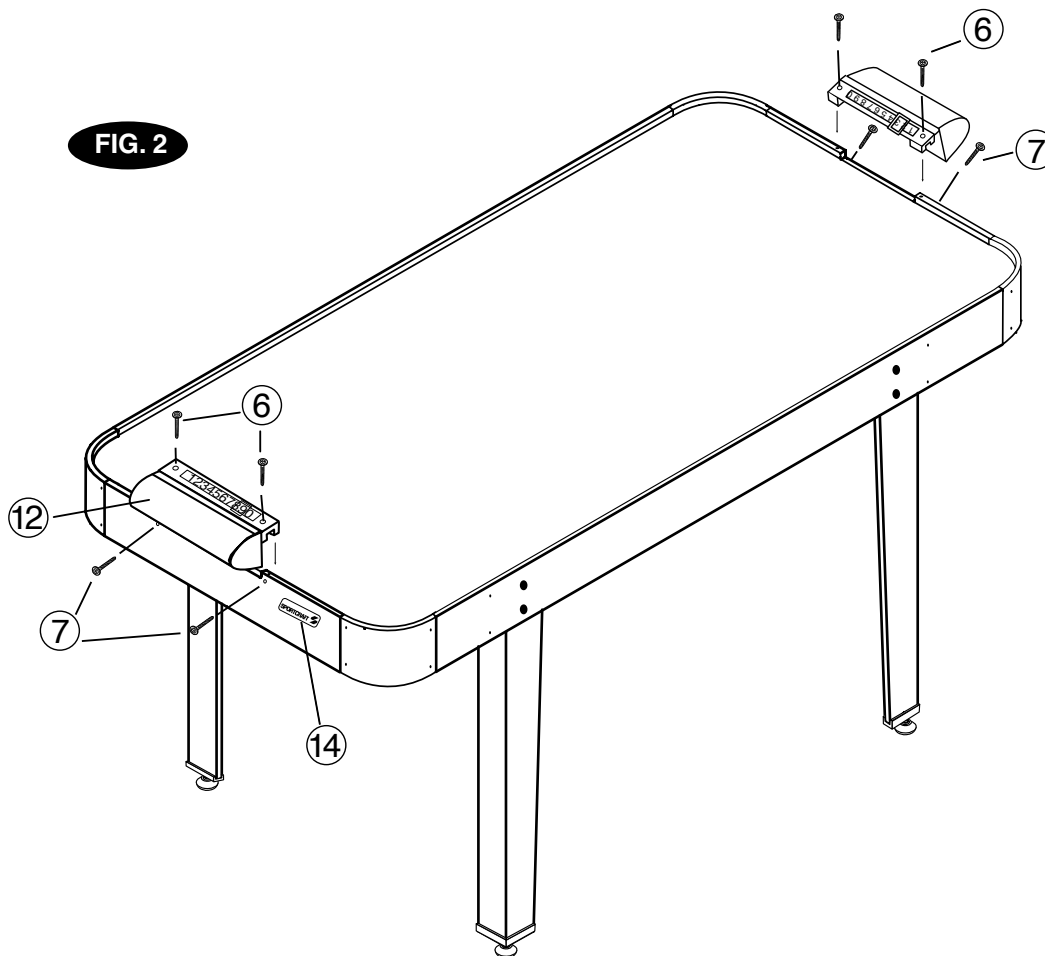

FIG. 2

- 6) Attach each of the two Goal Boxes (#12) to each end of the game using two of the 3.5 x 30mm Flat Head Screws (#6) and two of the 3.5 x 12mm Wood Screws (#7) per goal.



- 7) Plug in the power cord, and you are now ready to play.

HOCKEY GAME RULES:

- 1) This game is designed to be played with two (2) players, one at each end, or with four (4) players, two at each end of the game table.
- 2) Flip a coin to determine who will begin play, or a face-off can be held at the center of the table.
- 3) Play begins when the puck is placed on the playing surface. Players must hit the puck with the hand-held pushers and attempt to shoot into the opponent's goal.
- 4) One point is awarded when a puck is shot into the opponent's goal.
- 5) Winning the game: the winning score is accomplished by being the first player to reach a predetermined score or by being the player to score the most points within a given period of time.

MAINTAINING YOUR GAME:

- 1) Wipe playing surface with a clean cloth before and after each use.
- 2) While table is on, vacuum gently with a soft brush attachment on a vacuum cleaner.
- 3) In the event the puck becomes rough or scuffed, use a sheet of extra fine sand paper to lightly rub until the puck is smooth.
- 4) For faster play, wipe down the playing surface with a spray wax and cloth. (**NOTE:** Do not spray the wax directly on the table. Spray it on a cloth first.) Make sure the blower is on to prevent clogging the holes.

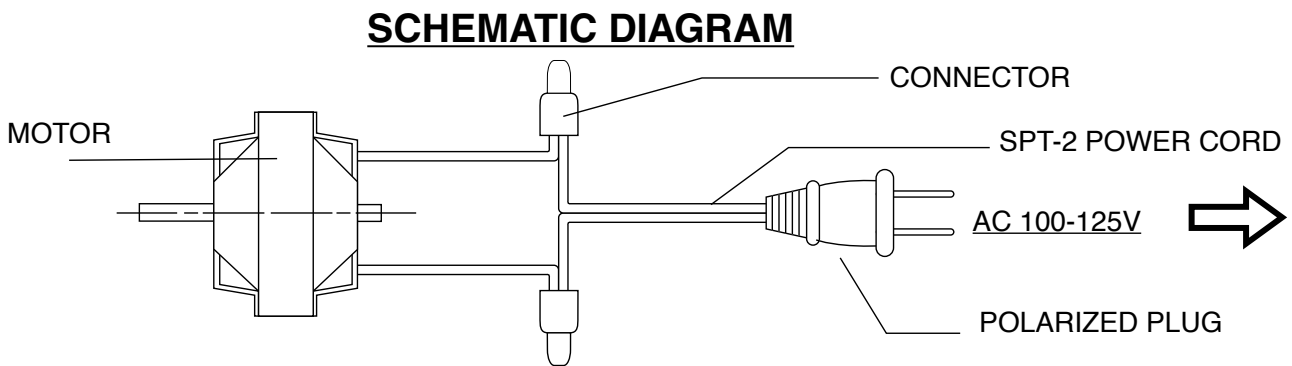

ELECTRIC RATING : AC 100-125 V, 50/60 HZ, 20 WATTS, 3000 RPM

Come Explore our Website! (www.sportcraft.com) Join our mailing list to receive more information on product updates and event announcements. Or, complete your warranty registration on-line. You can even order replacement parts, and learn more about our company.



Mt. Olive, NJ 07828

www.sportcraft.com

Printed in China

SPORTCRAFT

LIMITED WARRANTY

Limited Warranty

Sportcraft, Ltd. (the "Company") warrants the Product to be free from defects in workmanship and materials under normal use and conditions FOR A PERIOD OF ONE YEAR FROM THE DATE OF ORIGINAL PURCHASE in the United States and Canada.

Product Registration Card

The Product Registration Card must be filled out completely and mailed to the Company at the address printed on the card within 10 days from the date of your purchase of the Product.

What Is Covered

Except as provided below, this Limited Warranty covers all defects in materials and workmanship. This Limited Warranty is void if the Product is:

- Damaged through improper usage, negligence, misuse, abuse, transportation damage, acts of nature, or accident (including failure to follow the instructions supplied with the Product)
- Used in commercial applications or rentals
- Modified or repaired by anyone not authorized by the Company.

What Is Not Covered

This Limited Warranty does not cover expendable items such as batteries, light bulbs, fuses, accessories, cosmetic parts and other items that wear out due to normal usage.

What The Company Will Pay For

If during the one year Limited Warranty period, any part or component of the Product is found by the Company to be defective, the Company will repair or, at its option, will replace with a new Product (either the same or an equivalent model) without charge for labor or parts. The Company's obligation to repair or replace the Product, however, shall be limited to the original purchase price of the Product.

How To Obtain Warranty Service

In order to enforce your rights under this Limited Warranty, you must follow these procedures:

- You must have completed and mailed the Product Registration Card to the Company within 10 days of purchase of the Product.
- You must include THE ORIGINAL COPY OF YOUR SALES RECEIPT.
- You must call the Company's Consumer Service Department at 1-800-526-0244 from 9:00 A.M. to 5:00 P.M. (EST) to notify the Company of the nature of the problem and to obtain instructions for how to obtain servicing. At the Company's option, the Product may be serviced at your location or at a location designated by the Company.
- If you are instructed to return the Product to the Company for servicing, you are responsible for shipping the Product, at your expense, to the address designated by the Company in packaging that will protect against further damage.
- You must also include your name, address, daytime telephone number, model number of the Product and a description of the problem.
- The Company will pay for any shipping charges to return the repaired or replaced Product to you.

THIS LIMITED WARRANTY IS AVAILABLE ONLY TO THE ORIGINAL PURCHASER OF THE PRODUCT AND IS VALID IN THE UNITED STATES AND CANADA ONLY.

THE COMPANY'S LIABILITY IS LIMITED TO THE REPAIR OR REPLACEMENT, AT ITS OPTION, OF ANY DEFECTIVE PRODUCT AND SHALL NOT INCLUDE ANY LIABILITY FOR INDIRECT, INCIDENTAL OR CONSEQUENTIAL DAMAGES OF ANY KIND.

THIS WARRANTY IS EXPRESSLY MADE IN LIEU OF ALL OTHER WARRANTIES, EXPRESSED OR IMPLIED.

SOME STATES DO NOT ALLOW LIMITATIONS ON HOW LONG AN IMPLIED WARRANTY LASTS OR DO NOT ALLOW FOR EXCLUSION OF INCIDENTAL OR CONSEQUENTIAL DAMAGES. TO THAT EXTENT, THE ABOVE LIMITATIONS MAY NOT APPLY TO YOU.

This Limited Warranty gives you specific legal rights, but you may also have other rights that vary from state to state.

If you have questions regarding this Limited Warranty or the operation of the Product, you may call or write us:

SPORTCRAFT 
Sportcraft, Ltd.®
Consumer Service Department
313 Waterloo Valley Rd.
Mt. Olive, NJ 07828
1-800-526-0244
www.sportcraft.com

1102

****NOTE: Please save your original proof of purchase as it is needed should you require warranty service.**

