

Components and Hardware List

M1/4" x 2"
Allen Head Bolt

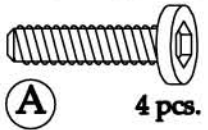

(A) 4 pcs.

1/4" Spring
Washer



(B) 8 pcs.

1/4" Flat Washer

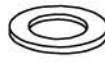

(C) 8 pcs.

M1/4" x 3/4"
Allen Head Bolt

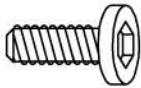

(D) 4 pcs.

4mm Allen Wrench

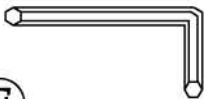

(E) 1 pc.

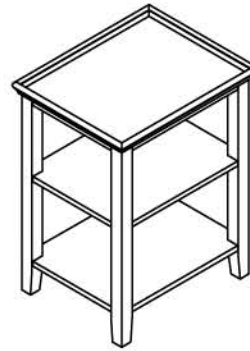

#1210
Tray Top Accessory Table

Leg

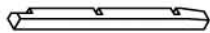

(F) 4 pcs.

Table Top

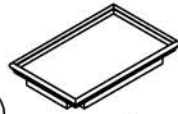

(G) 1 pc.

Bottom Shelf

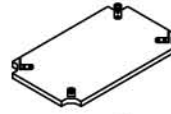

(H) 1 pc.

Middle Shelf

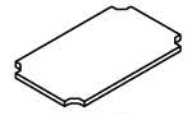

(I) 1 pc.

Be sure to check all packing material carefully for small parts, which may have come loose inside the carton during shipment.

Step 1: Place the Table Top (G), upside down on a soft non-abrasive surface, such as a blanket or carpet.

Step 2: Attach the LEGS (F) to the underneath side of the Table Top with the 2" long Allen-Head Bolts (A), Spring Washers (B) and Flat Washers (C). Do not fully install bolts until after next step.

Step 3: Attach the Middle and Bottom Shelves (H & I) to the LEGS using the 3/4" long Allen-Head Bolts (D), and same washers as in previous step. Tighten all Bolts using the Allen Wrench (E).

Step 2

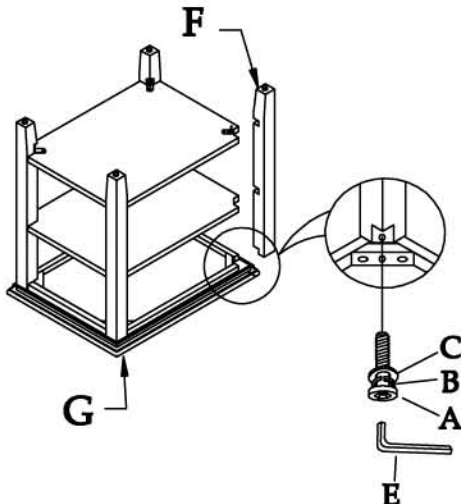

Step 3

