

ASSEMBLY/INSTALLATION INSTRUCTIONS

The Master Switch Box may be installed as a **PORTABLE UNIT**, using the included cord and mounting it in any convenient under cabinet area.

It may also be installed as a **DIRECT WIRE UNIT** and be hard wired into a convenient under cabinet area using new or existing supply wire. Please determine which method of installation you will be using and follow the appropriate directions.

The Master Switch Box will only work with Xenon Under Cabinet Fixtures and Accessories from Quoizel.

The **maximum** number of 18W Xenon Bulbs that may be connected to the Master Switch Box is 36 bulbs.

The **MAXIMUM DISTANCE** the Master Switch Box can be installed from a grounded receptacle is determined by the cord length (36") that is installed at the factory for use as a **PORTABLE UNIT**.

The **MAXIMUM DISTANCE** that each Under-Cabinet Fixture and Master Switch Box can be installed from each other is determined by the length of the Cord or the width of the Interconnect Plug purchased to connect them.

TURN OFF POWER SUPPLY BEFORE BEGINNING INSTALLATION.

ONLY FOR USE WITH PORTABLE LUMINAIRES AND ACCESSORIES IDENTIFIED BY THE MANUFACTURER'S INSTRUCTIONS.

UNDER CABINET FIXTURES AND ACCESSORIES

UNDER CABINET FIXTURES AND MASTER SWITCH BOX FINISHES

BX=BRONZE FINISH
 SS=STAINLESS STEEL FINISH
 W=WHITE FINISH

INTERCONNECT CORDS AND INTERCONNECT PLUG FINISHES

BR=BROWN FINISH
 BL=BLACK FINISH
 W=WHITE FINISH

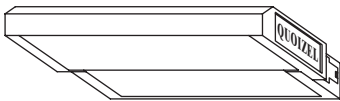

UC1108-1 LIGHT

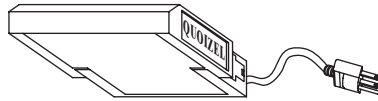

UCMS2205
MASTER SWITCH BOX



UCB2118CL
18W XENON LAMP

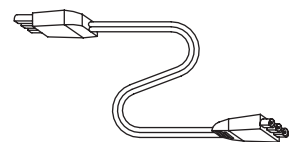

UCL2209
9" INTERCONNECT CORD

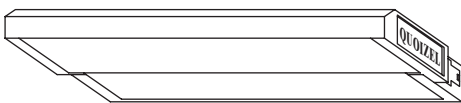

UC1116-2 LIGHT



UCIC2201
INTERCONNECT PLUG

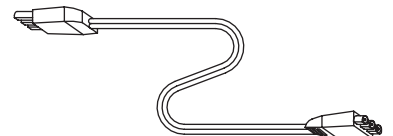

UCL2214
14" INTERCONNECT CORD

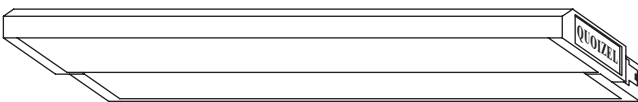

UC1124-3 LIGHT

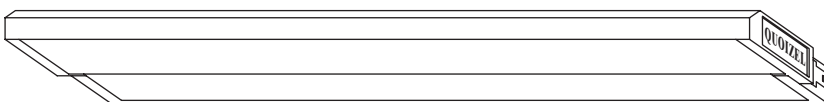

UC1132-4 LIGHT



UCL2221
21" INTERCONNECT CORD

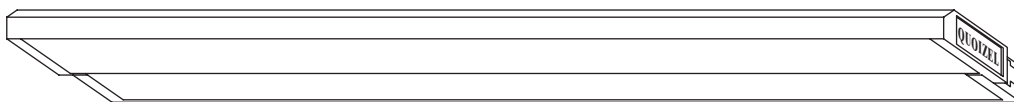

UC1140-5 LIGHT

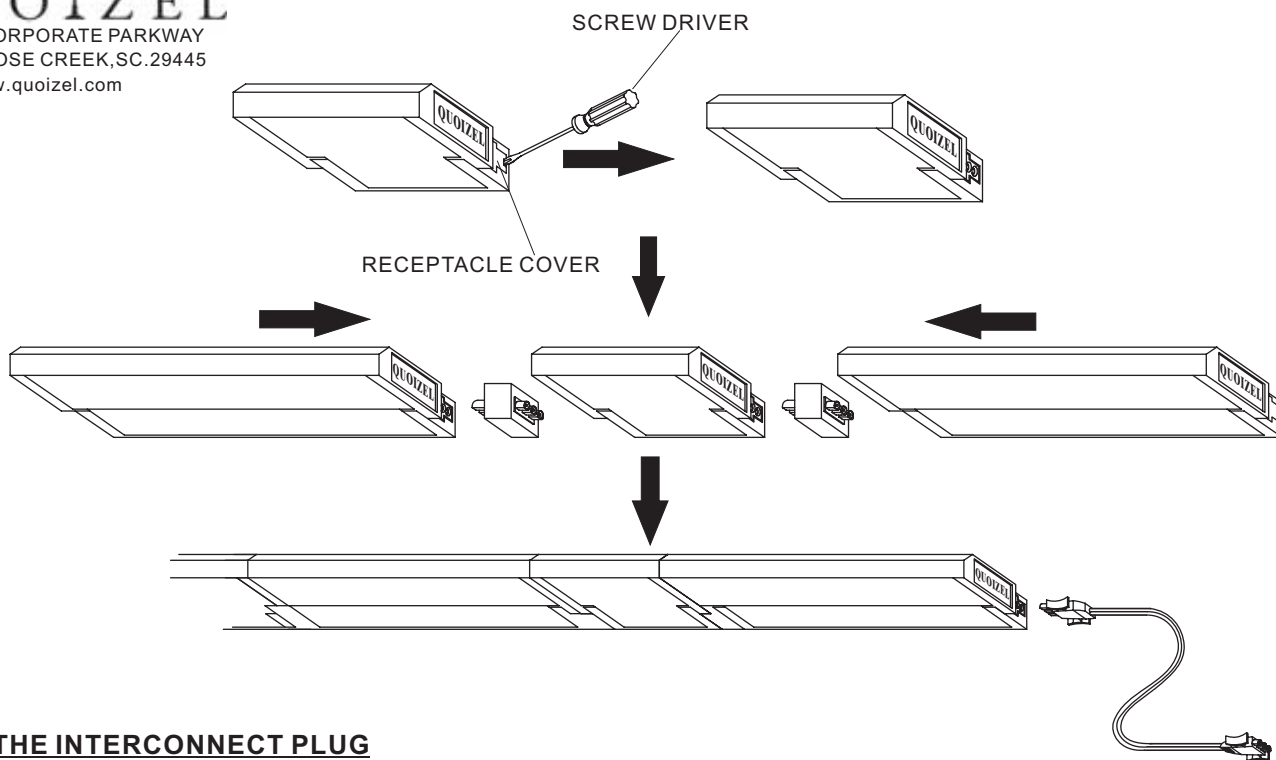

USING THE INTERCONNECT PLUG

1. The Interconnect Plug will allow the Master Switch Box and the Under Cabinet Fixtures to be installed on both or either side of one another, whichever is convenient to the installation.
2. Begin by removing the receptacle cover on the side or sides of the Master Switch box that you intend to use. Use a small screw driver to remove the receptacle cover. Keep the receptacle cover in place if not using the receptacle.
3. Install the Interconnect Plug as shown in the illustration. You may also incorporate the Interconnect Cords shown below to achieve the lighting plan you had in mind.
4. Once you have all of your units secured to the cabinet and safely plugged together, you may restore your power supply. The portable unit can now be plugged into the power outlet and the direct wire unit can now have the power restored back to ON.

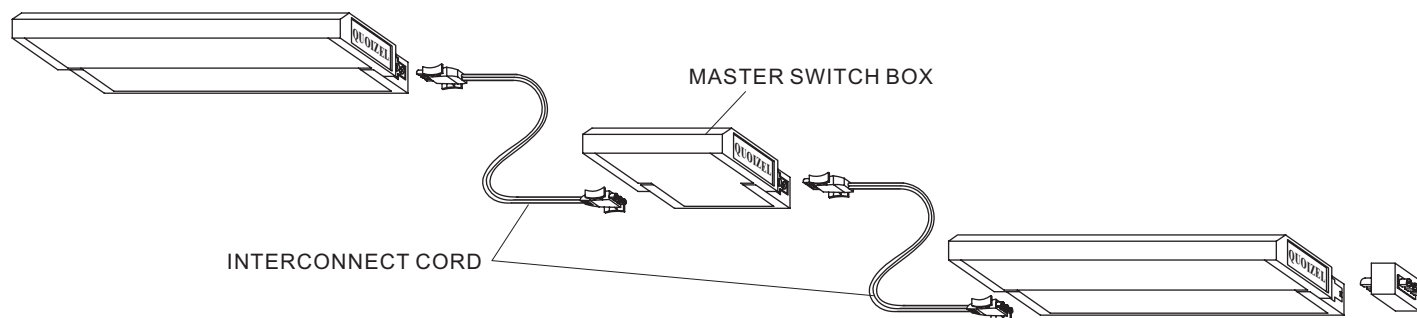

USING THE INTERCONNECT CORDS

1. The Interconnect Cords will allow the Master Switch Box and the Under Cabinet Fixtures to be installed on both or either side of one another, whichever is convenient to the installation.
2. Begin by removing the receptacle cover on the side or sides of the Master Switch Box that you intend to use. Use a small screw driver to remove the receptacle cover. Keep the receptacle cover in place if not using the receptacle.
3. The Interconnect Cords come in lengths of 9", 14", and 21". Install the Interconnect Cord you wish to use into the Master Switch Box and into the Under Cabinet Fixtures. You may mix and match the assorted lengths to achieve the lighting plan you had in mind. You can also incorporate the Interconnect Plug shown above along with your cords..
4. Once you have all of your units secured to the cabinet and safely plugged together, you may restore your power supply. The portable unit can now be plugged into the power outlet and the direct wire unit can now have the power restored back to ON.

ONLY FOR USE WITH PORTABLE LUMINAIRES AND ACCESSORIES IDENTIFIED BY THE MANUFACTURER'S INSTRUCTIONS.