

INSTALLATION MANUAL



PRC LCD CEILING MOUNT

Premier Mounts
3130 E. Miraloma Avenue
Anaheim, CA 92806

Phone: (800) 368-9700
mounts@mounts.com

Fax: (800) 832-4888
www.mounts.com



Table of Contents

Parts List	- 3 -
Installation Tools	- 3 -
AST-2446 Installation	- 5 -
PRC Installation	- 6 -
Display Installation	- 6 -
Tension Adjustment	- 7 -
UFP-220 Adapter Plate	- 7 -
Technical Specifications	- 7 -
Warranty	- 8 -
Contact Premier Mounts	- 8 -
Warning Statements	- 8 -



Parts List

NOTE: This ceiling mount is shipped with all proper installation hardware and components. Make sure that none of these parts are missing and/or damaged before beginning installation. If there are parts missing and/or damaged, please stop the installation and contact Premier Mounts (800-368-9700).

NOTE: Please review all WARNING and CAUTION statements (see Page 8) before beginning the installation of the PRC.

AST-2446 (Qty 1)

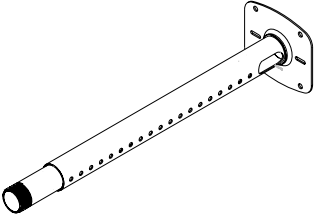

NOTE: The AST-2446 is not included with the PRC-LA. Customers may purchase the AST-2446 separately or use a custom length of 1-1/2" NPT.

PRC-LA (Qty 1)

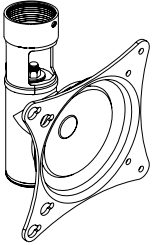

M4 x 10mm
Phillips Pan Head
(Qty 4)



M6 x 8mm Set
Screw (Qty 1)



UFP-220 Adapter
Plate (Qty 1)

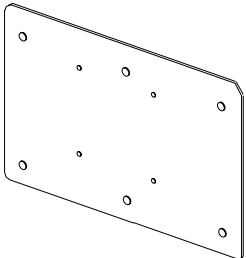

M4 x 5mm
Phillips Screws
(Qty 4)



M4 x 10mm Flat
Head Phillips
Screws (Qty 6)



Installation Tools

Phillips Head Screw Driver
Pencil
14mm Socket (Supplied)
M3 Allen Wrench (Supplied)

Soft Material/ Blanket
Tape Measure
3/4" Open-End Wrench

Drill Gun
Socket Wrench
Level (Supplied)



Features:

The PRC-LA allows tilt and pivot adjustments $\pm 15^\circ$ from center, 360° side-to-side swivel, and cable access. The AST-2446 allows height adjustment from 24 to 46 inches. Plus it also features two cable access openings.

PRC-LA

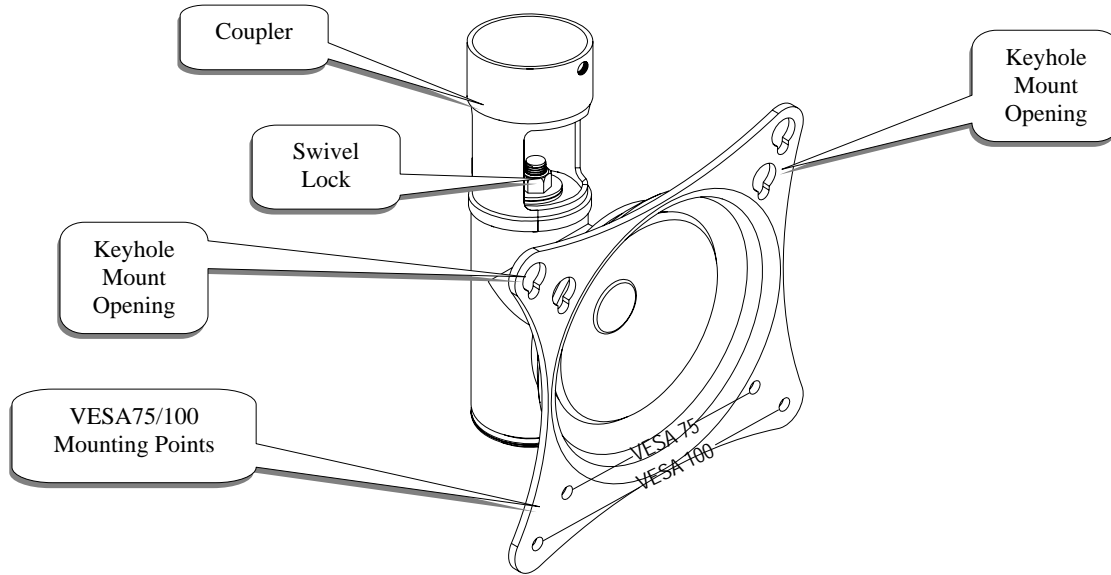

AST-2446

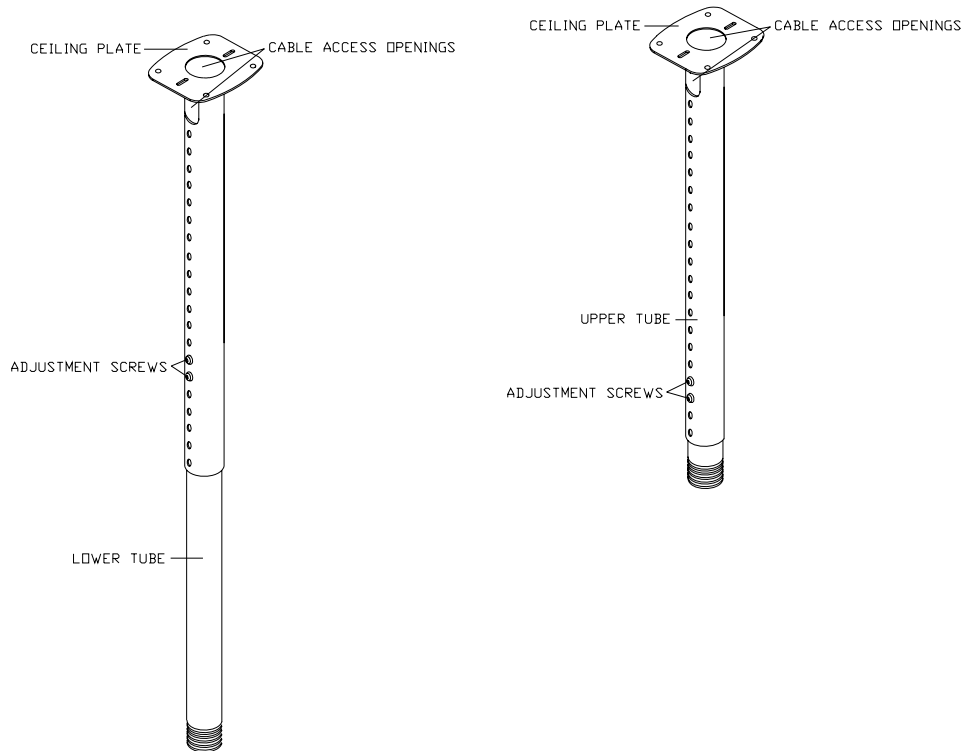

NOTE: The AST-2446 may be substituted for a custom pre-cut length of threaded 1-1/2" NPT pipe.



AST-2446 Installation

NOTE: If the AST-2446 will not be used to mount the PRC, then a suitable piece of threaded pipe can be used. These instructions will tell the user how to mount an AST-2446 to the ceiling. If a custom piece of threaded pipe is used, it is the responsibility of the user to determine how best to mount the PRC and pipe.

Single Stud Installation – Wood screws
(Commercially Available)

Solid Surface Installation – Concrete wedge
anchors
(Commercially
Available)

1. Secure the ceiling plate to the ceiling structure.
2. Use suitable hardware (commercially available) depending on your installation environment to secure the two (2, or 4, depending on the structure) mounting points found on the ceiling plate to the ceiling structure.

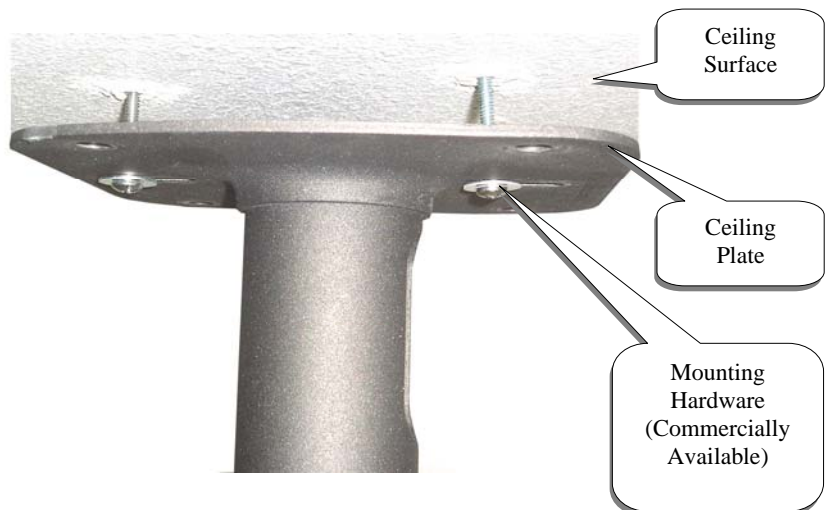
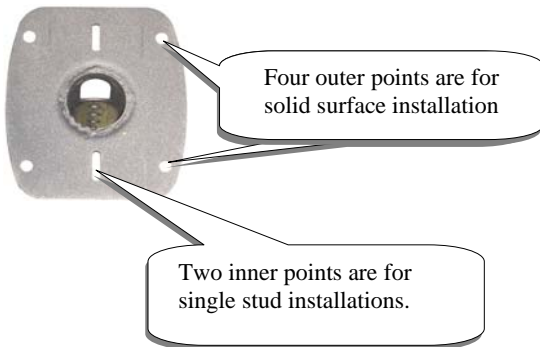

3. To adjust the height of the AST-2446, remove the adjustment screws (Page 4), determine the desired height, and re-insert the adjustment screws to lock the AST-2446 into the desired position.



PRC Installation

1. Screw the PRC-LA coupling adapter to the AST-2446 adapter or 1½" (NPT) Pipe.
2. Secure the coupling with the M6 set screw (supplied).

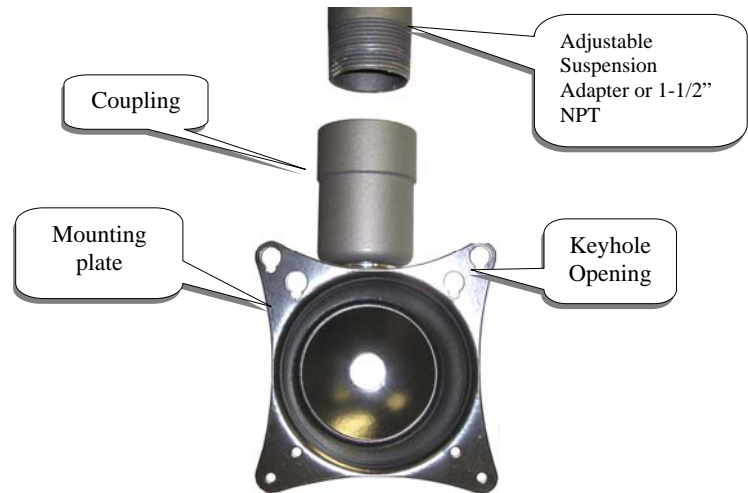

Display Installation

1. Place the display on a soft flat surface, face down.
2. Insert the two upper screws (thread on 3 turns). Do not insert the lower screws at this time.

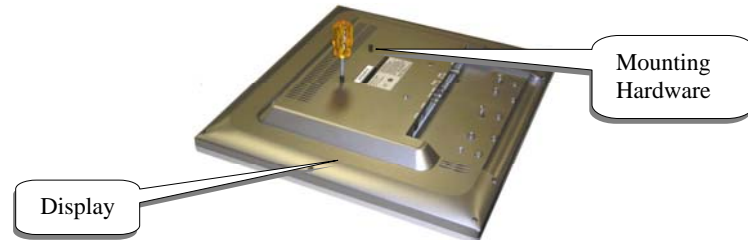

3. Lift the display and carefully guide the display with the two screws into the keyhole openings.

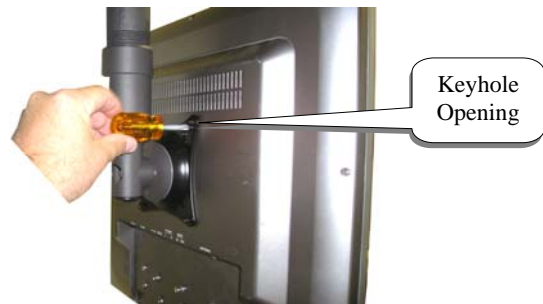

4. Let the display rest in this position while you insert the lower mounting screws.
5. Tighten both the upper and lower mounting screws at this time.

CAUTION: Do not over tighten the screws to the monitor. Failure to do so could result in damaging the monitor or the mounting points.

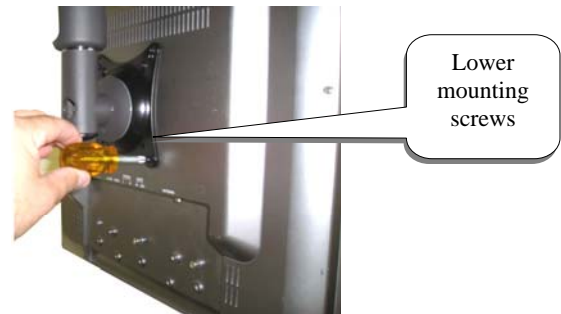

NOTE: If your flat panel has a 200mm x 100mm mounting pattern, the UFP-220 Adapter Plate must be used.



Tension Adjustment

1. **Swivel Adjustment** – Use a 3/4” wrench to tighten and loosen the swivel adjustment.
2. **Tilt Adjustment** - Use a 14mm socket to tighten and loosen the tilt adjustment.
3. After everything has been tightened and the orientation has been determined, tighten the set screw, using the included M3 Allen wrench.

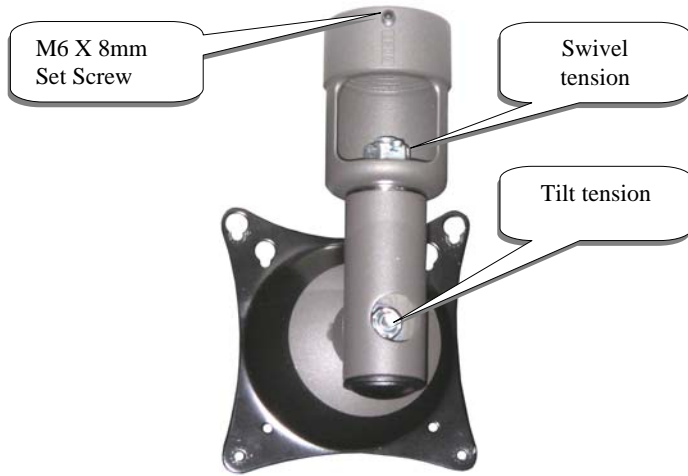

UFP-220 Adapter Plate

1. Attach the UFP-220 Adapter Plate to the back of the display using the six (6) M4 x 10mm flat head screws.
2. Attach the PRC mounting plate to the back of the UFP-220 using the four (4) M4 x 5 mm screws.

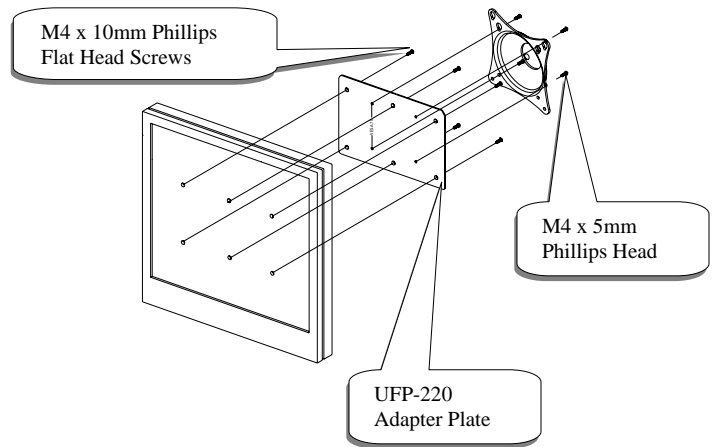

Technical Specifications

All measurements are in inches (mm)

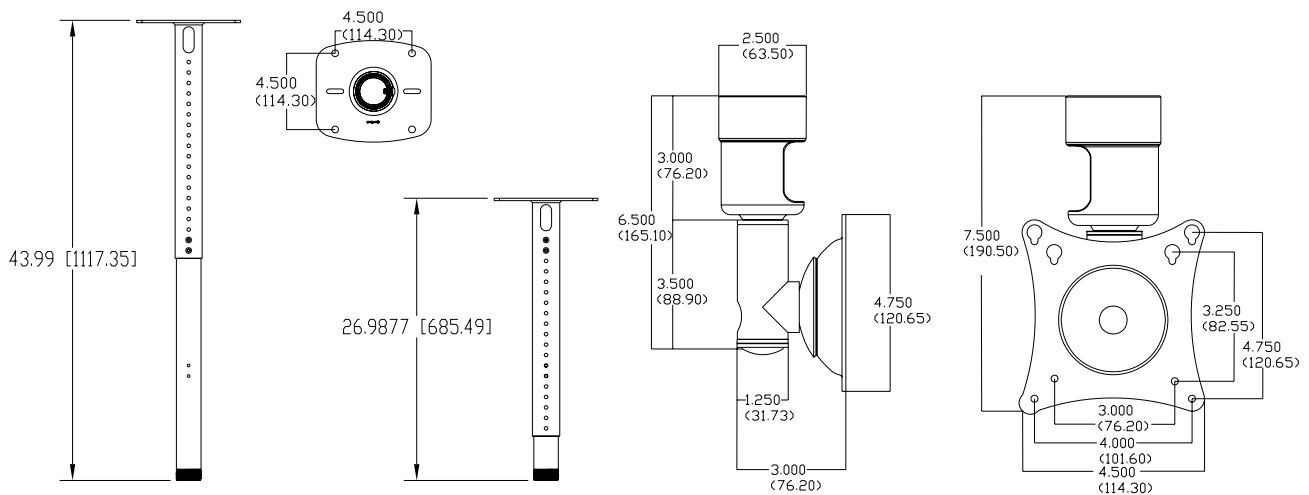



Warranty

Limited Lifetime Warranty

All Premier Mounts products carry a limited lifetime warranty from ship date against defects in materials and workmanship. Premier Mounts is not liable for improper installation that results in damage to mounts, adapters, display equipment or personal injury. Any modification to the existing mount will void the manufacturers' warranty.

DISCLAIMER OF WARRANTY.

THE FOREGOING WARRANTY IS IN LIEU OF ALL OTHER WARRANTIES, EXPRESS OR IMPLIED, INCLUDING BUT NOT LIMITED TO THE IMPLIED WARRANTIES OF MERCHANTABILITY AND FITNESS FOR A PARTICULAR PURPOSE.

Contact Premier Mounts

In the event of missing and/or damage equipment, or technical questions, the following information can help in the completion of the installation.

Customer Service – (800) 368-9700

Technical Support – techsupport@mounts.com

Warning Statements

WARNING: PREMIER MOUNTS DOES NOT WARRANT AGAINST DAMAGE CAUSED BY THE USE OF ANY PREMIER MOUNTS PRODUCT FOR PURPOSES OTHER THAN THOSE FOR WHICH IT WAS DESIGNED OR DAMAGE CAUSED BY UNAUTHORIZED ATTACHMENTS OR MODIFICATIONS, AND IS NOT RESPONSIBLE FOR ANY DAMAGES, CLAIMS, DEMANDS, SUITS, ACTIONS OR CAUSES OF ACTION OF WHATEVER KIND RESULTING FROM, ARISING OUT OF OR IN ANY MANNER RELATING TO ANY SUCH USE, ATTACHMENTS OR MODIFICATIONS.

WARNING: THE CEILING STRUCTURE MUST BE CAPABLE OF SUPPORTING AT LEAST FIVE TIMES THE MONITORS WEIGHT. IF NOT, THE WALL STRUCTURE MUST BE REINFORCED. PROPER INSTALLATION PROCEDURE BY A QUALIFIED SERVICE TECHNICIAN, AS OUTLINED IN THE INSTALLATION INSTRUCTIONS, MUST BE ADHERED TO. FAILURE TO DO SO COULD RESULT IN SERIOUS PERSONAL INJURY, OR EVEN DEATH.

WARNING: SAFETY MEASURES MUST BE PRACTICED AT ALL TIMES DURING THE INSTALLATION OF THIS PRODUCT. USE PROPER SAFETY GEAR AND TOOLS FOR THE INSTALLATION PROCEDURE TO PREVENT PERSONAL INJURY.

WARNING: PRIOR TO THE INSTALLATION OF THIS PRODUCT, THE INSTALLATION INSTRUCTIONS SHOULD BE READ AND COMPLETELY UNDERSTOOD. THE INSTALLATION INSTRUCTIONS MUST BE READ TO PREVENT PERSONAL INJURY AND PROPERTY DAMAGE. KEEP THESE INSTALLATION INSTRUCTIONS IN AN EASILY ACCESSIBLE LOCATION FOR FUTURE REFERENCE.



Indicates that the power plug is to be disconnected from the power outlet.



Contact Premier Mounts with any questions – (800) 368-9700.



Safety precautions must be taken at all times.



Warning and Caution statements.



Do not install on a structure that is prone to vibration, movement or chance of impact. Failure to do so could result in damage to the flat panel display and/or damage to the mounting surface.



Do not install near heater, fireplace, direct sunlight, air conditioning or any other source of direct heat energy. Failure to do so may result in damage to the flat panel display and could increase the risk of fire.



At least two qualified people should perform the installation procedure. Injury and/or damage can result from dropping or mishandling the flat panel display.

NORTH AMERICA	EUROPE	AUSTRALIA, NEW ZEALAND, OCEANIA (DISTRIBUTOR)
3130 East Miraloma Avenue Anaheim, CA 92806 USA USA and Canada – Phone: 800-368-9700 Fax: 800-832-4888	Swallow House, Shilton Industrial Estate, Shilton, Coventry, England CV79JY Phone: +44 (0) 2476 614700 Fax: +44 (0) 2476 614710	P.O. Box 295 Mordialloc Victoria 3195 Australia Phone: 03 9586 6330 www.premiermounts.com.au

Other Locations – Phone: (001)-714-632-7100; Fax: (001)-714-632-1044
©Premier Mounts 2007