

Thank you for purchasing this quality product. Be sure to check all packing material carefully for small parts which may have come loose inside the carton during shipment. Separate, identify, and count all parts and metal hardware. Compare with parts list and hardware illustrations to be sure all parts are present. If any part(s) are missing or damaged, phone, fax, or mail to our Customer Service Department. For efficient and speedy service, please indicate the model number and code letter of part(s) needed.

ATTENTION: SOME LETTERED PARTS LISTED ON THE INSTRUCTION SHEET MAY NOT BE IN PARTS BAG AS THEY MAY ALREADY BE ASSEMBLED. CAREFULLY CHECK PARTS AND PACKING MATERIALS PRIOR TO ORDERING REPLACEMENTS.

Tools Required for assembly: Phillips Screwdriver (not included)

 **WARNING:** CHOKING HAZARD-SMALL PARTS
NOT FOR CHILDREN UNDER THREE YEARS OF AGE

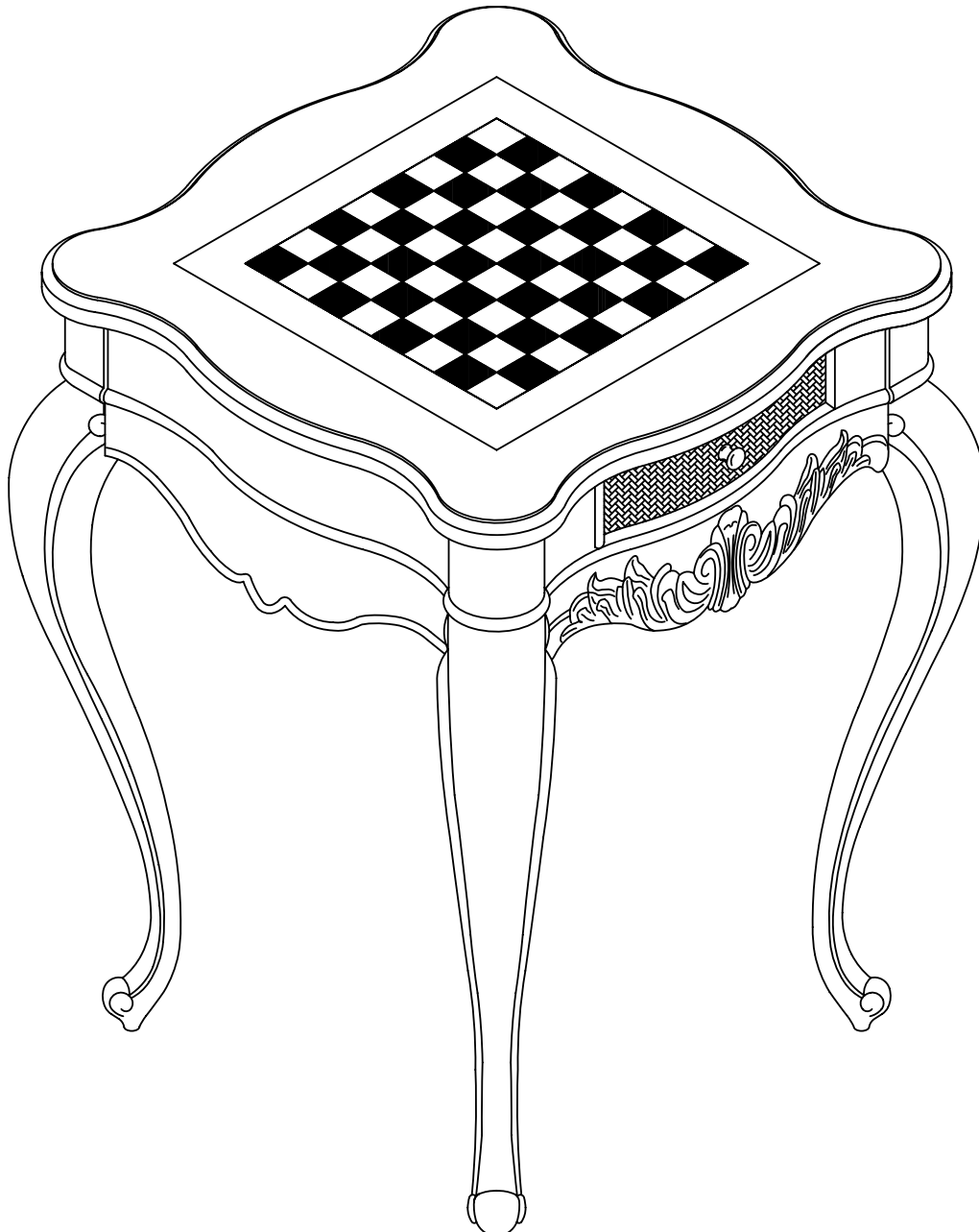

PARTS

- (A) TABLE TOP
- (B) LEGS (4)
- (C) GAME BOARD
- (D) DRAWERS (2)
- (E) CHESS PIECES
- (F) BACKGAMMON PIECES
- (G) DICE (5)
- (H) DICE CUP
- (I) PLAYING CARDS

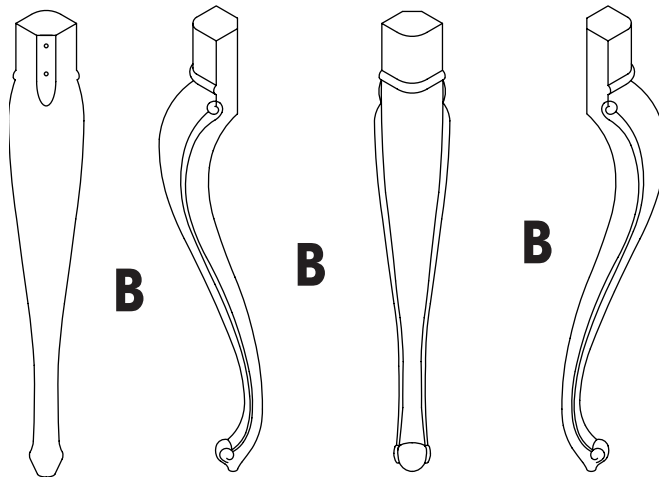
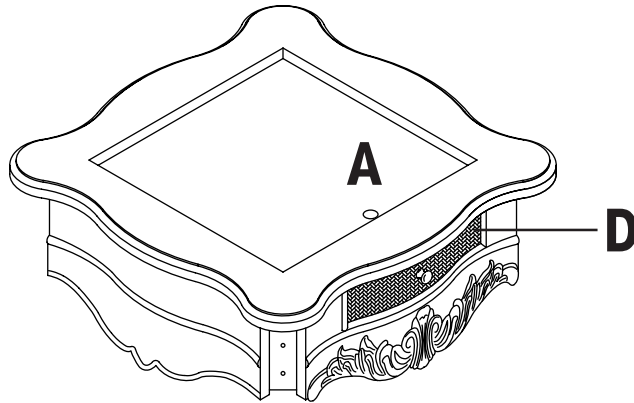
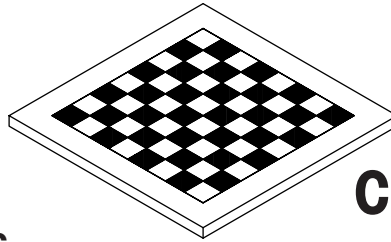

HARDWARE



J
(8 PIECES)

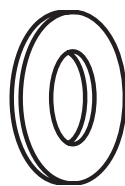

K
(8 PIECES)



L
(8 PIECES)

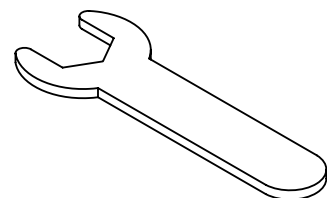

M
(2 PIECES)

STEP 1

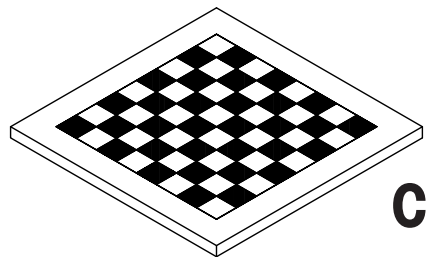
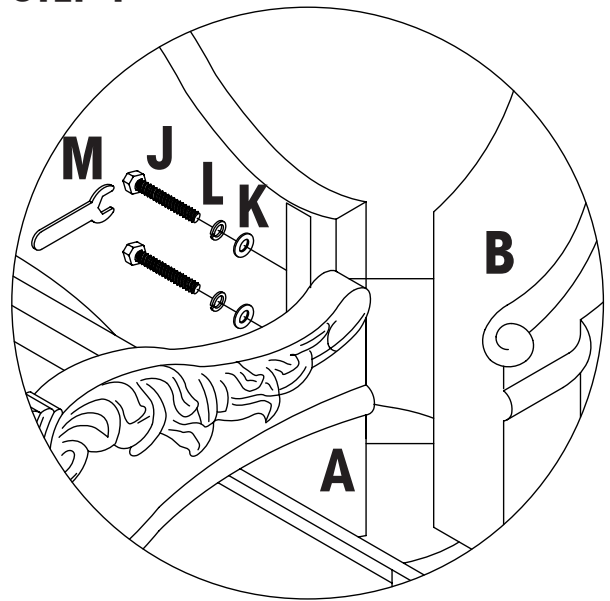
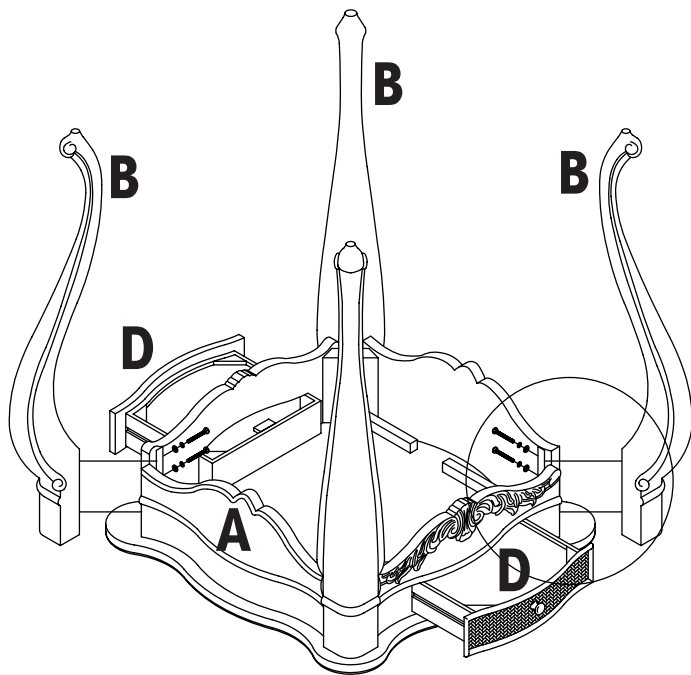

STEP 2

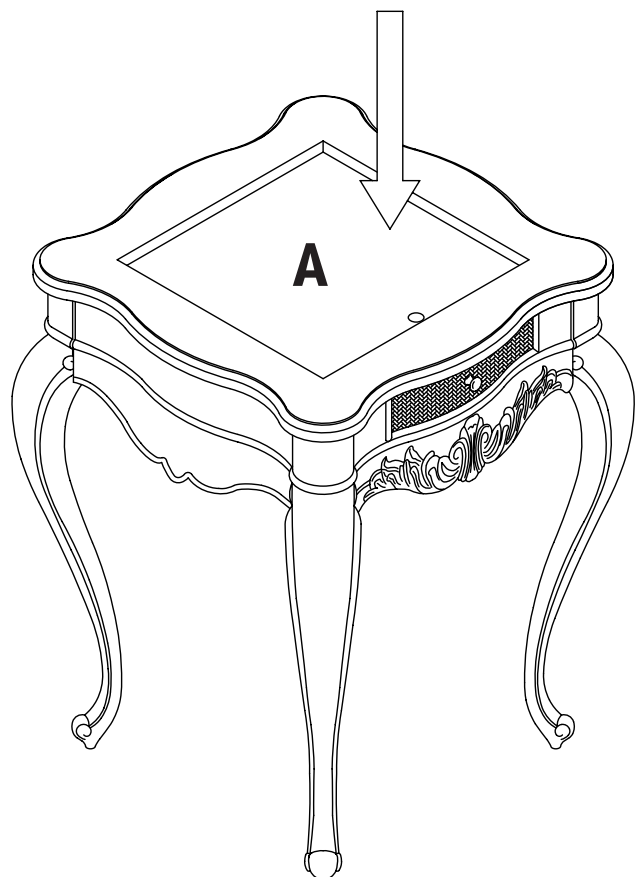

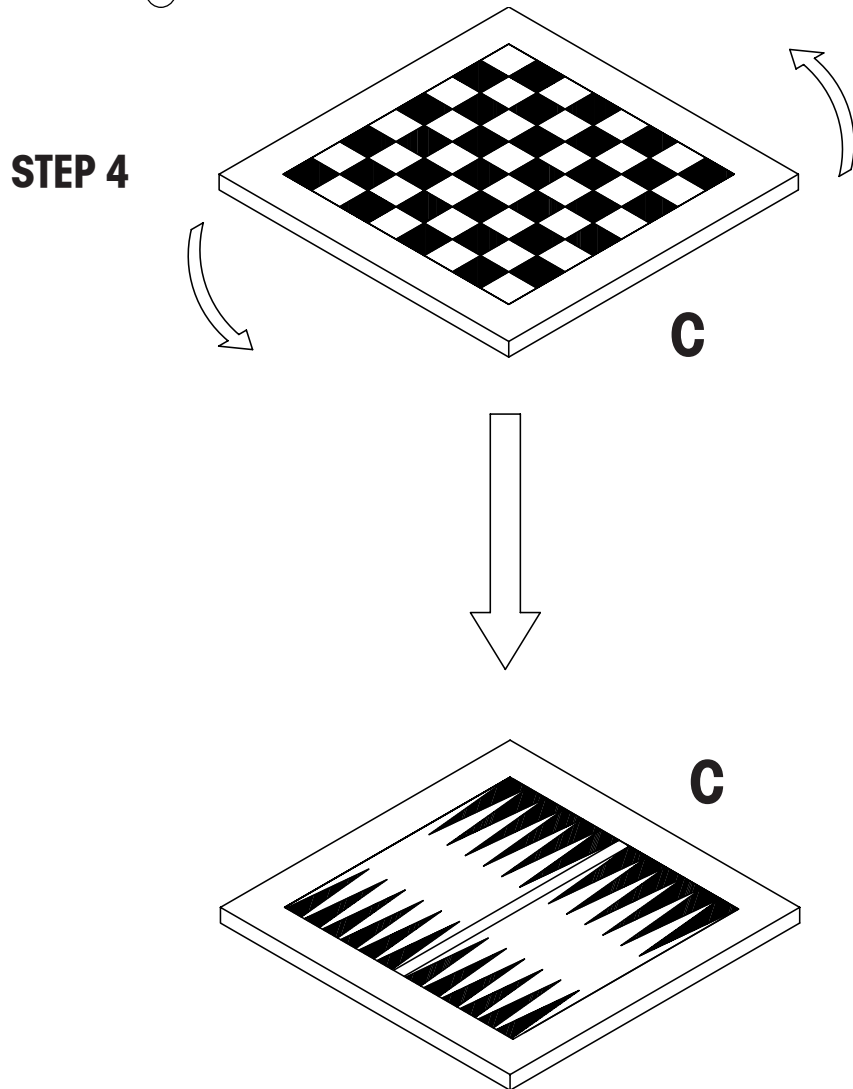
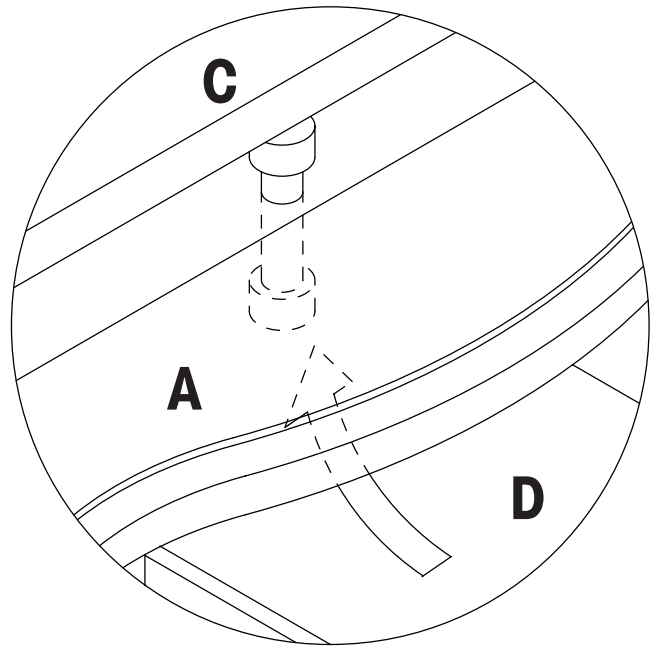
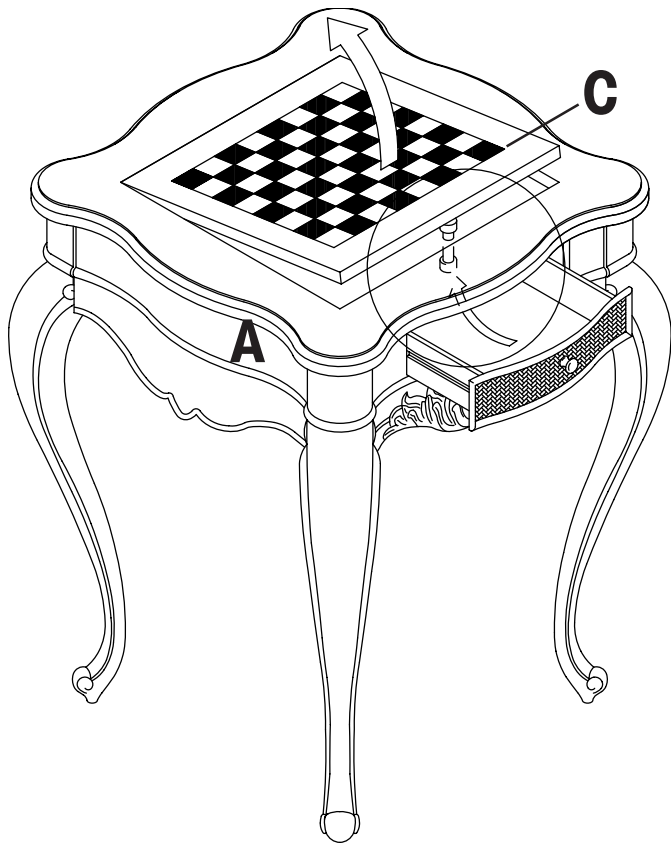

STEP 5

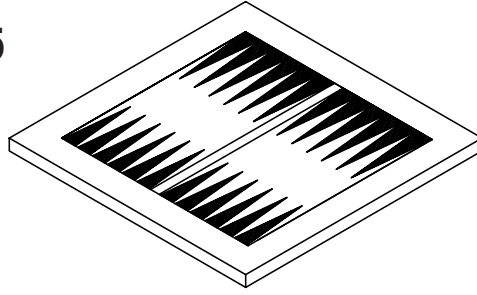

C

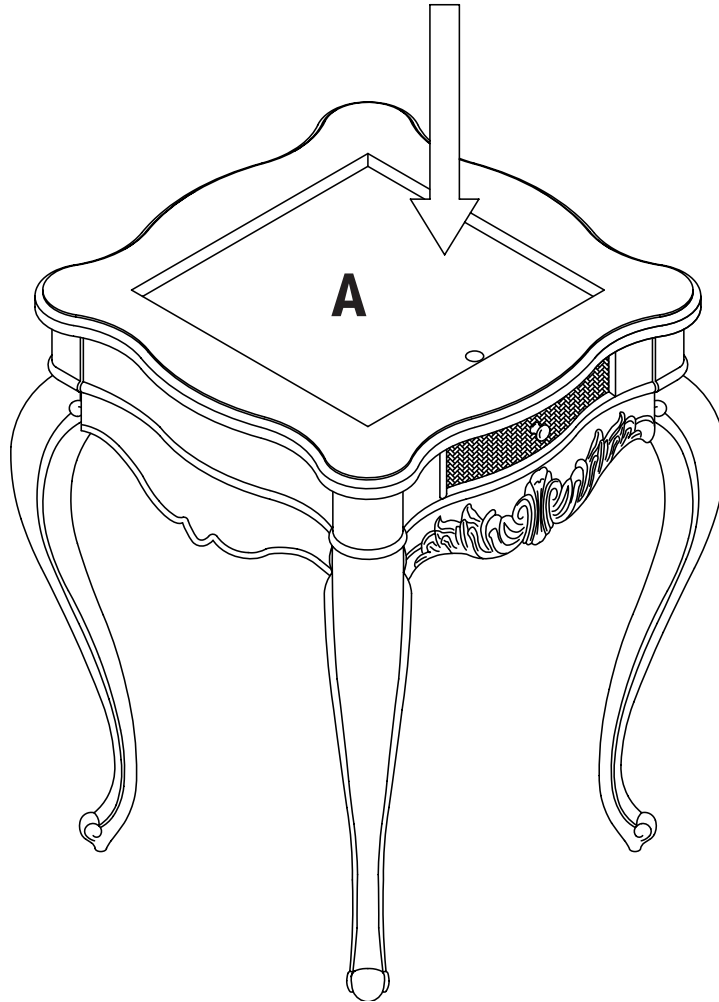

A

IF YOU HAVE A PROBLEM, WE WANT TO HAVE THE OPPORTUNITY TO MAKE IT RIGHT!

Should there be any missing or defective part(s),

Fax this form to (310) 841-0842

or call Customer Service at (800) 622-4456 or (310) 204-2224

Have your model number and part code letter handy.

MODEL NO. 659-207

© 2004 Powell

Part Letter Description Quantity

Name _____

Address _____

Daytime Phone () _____

Reason for replacement _____

Place of purchase _____