

Made in China

Thank you for purchasing this quality product. Be sure to check all packing material carefully for small parts which may have come loose inside the carton during shipment. Separate, identify, and count all parts and metal hardware. Compare with parts list and hardware illustrations to be sure all parts are present. If any part(s) are missing or damaged, phone, fax, or mail to our Customer Service Department. For efficient and speedy service, please indicate the model number and code letter of part(s) needed.

ATTENTION: SOME LETTERED PARTS LISTED ON THE INSTRUCTION SHEET MAY NOT BE IN PARTS BAG AS THEY MAY ALREADY BE ASSEMBLED. CAREFULLY CHECK PARTS AND PACKING MATERIALS PRIOR TO ORDERING REPLACEMENTS.

Tools Required for assembly: Allen Wrench (included).

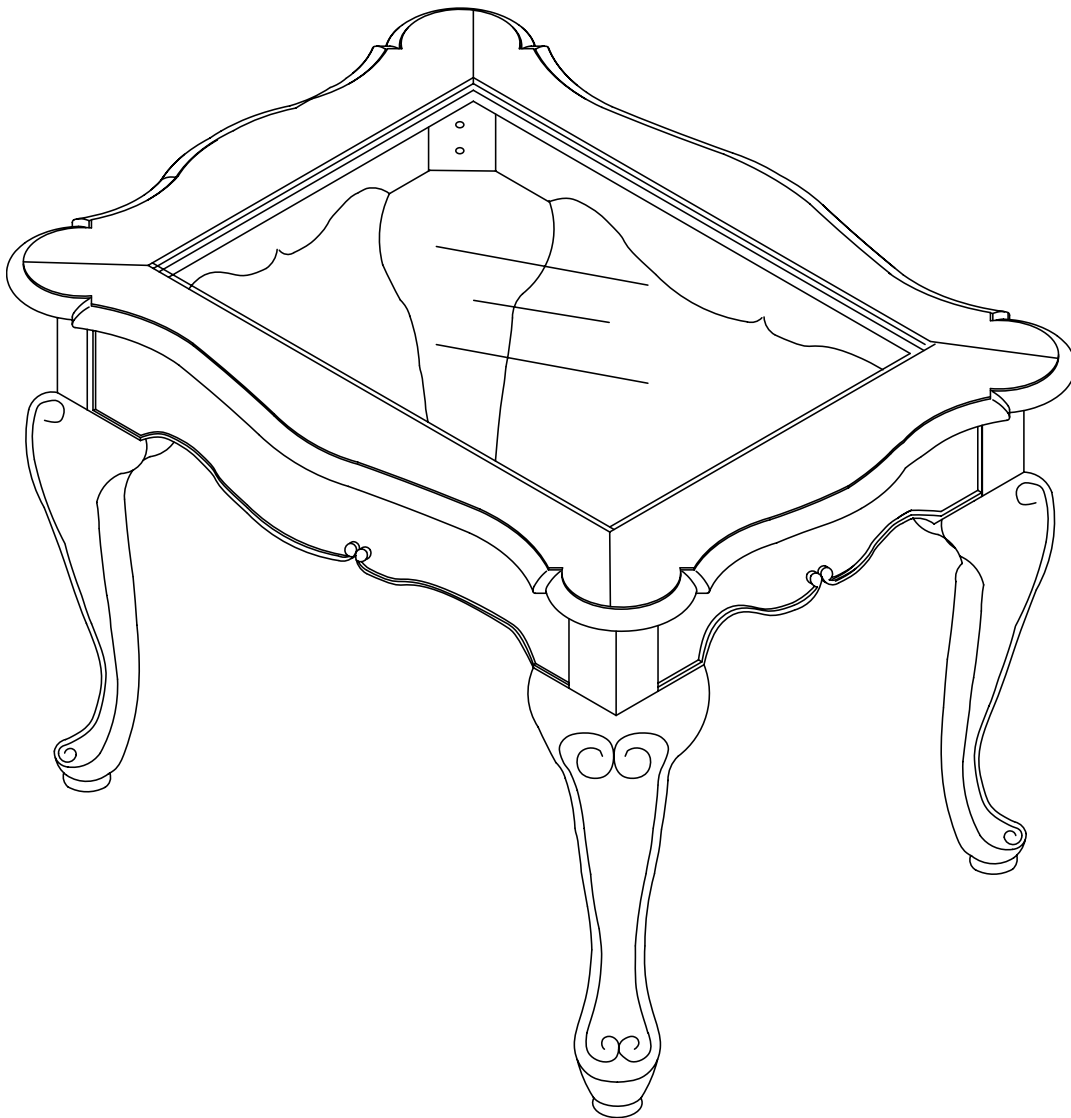

# PARTS

- (A) GLASS TOP
- (B) TOP FRAME
- (C) LEGS (4)

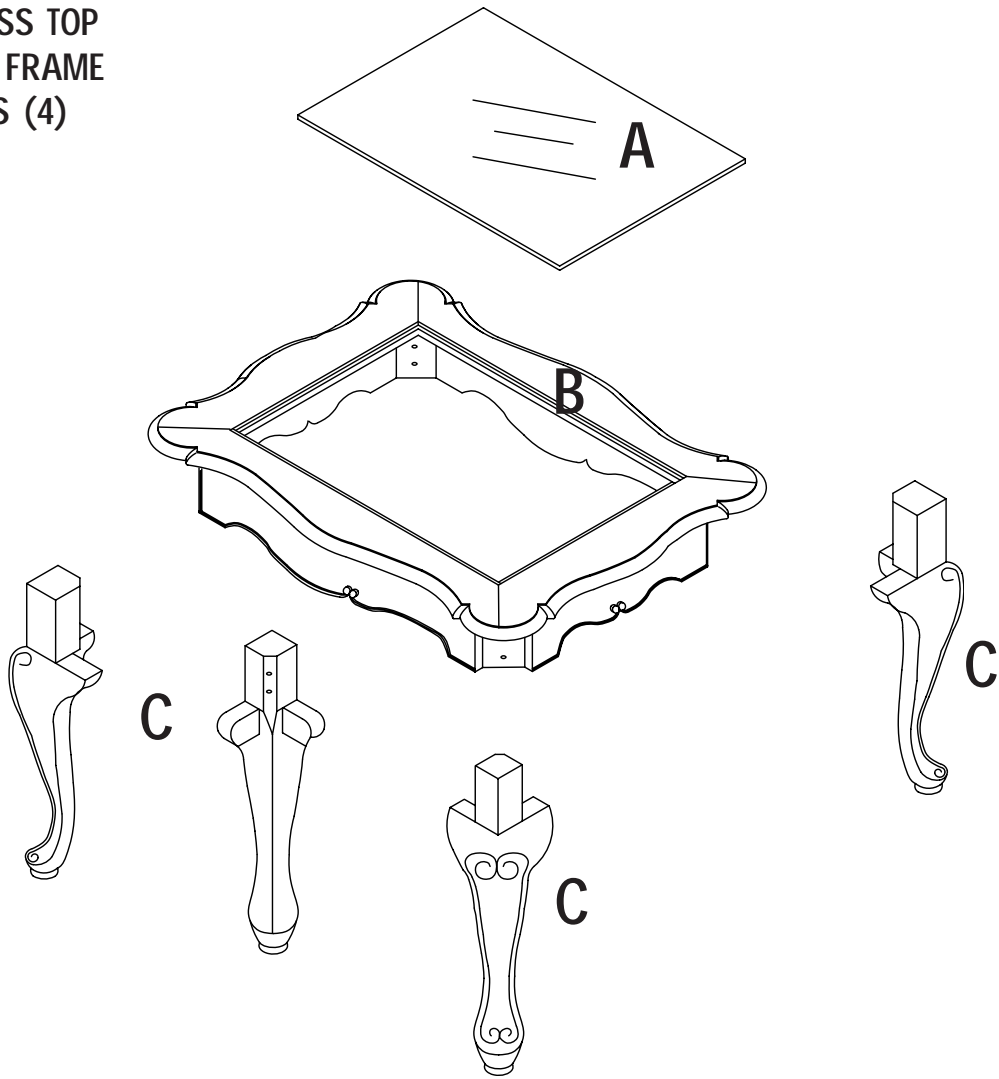

# HARDWARE

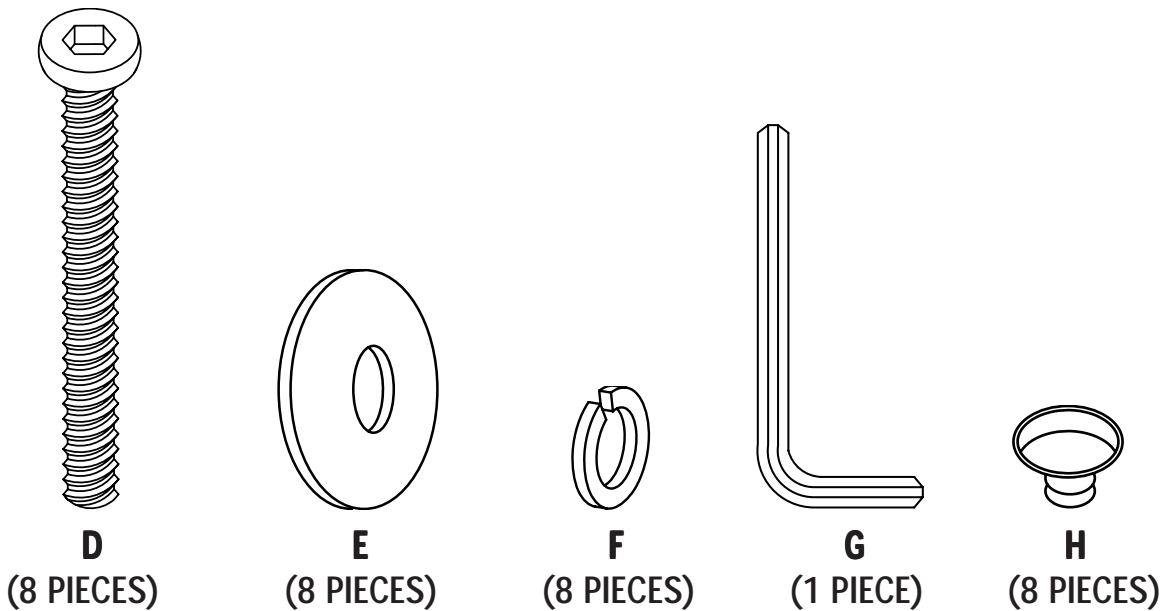

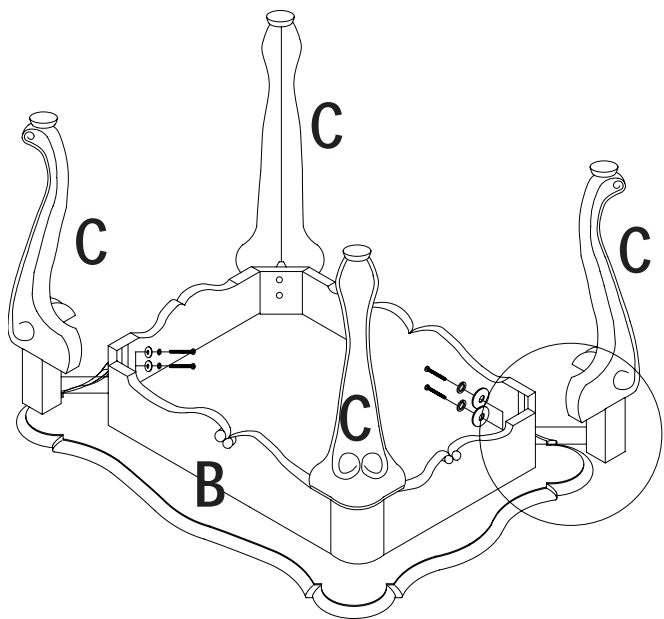

STEP 1

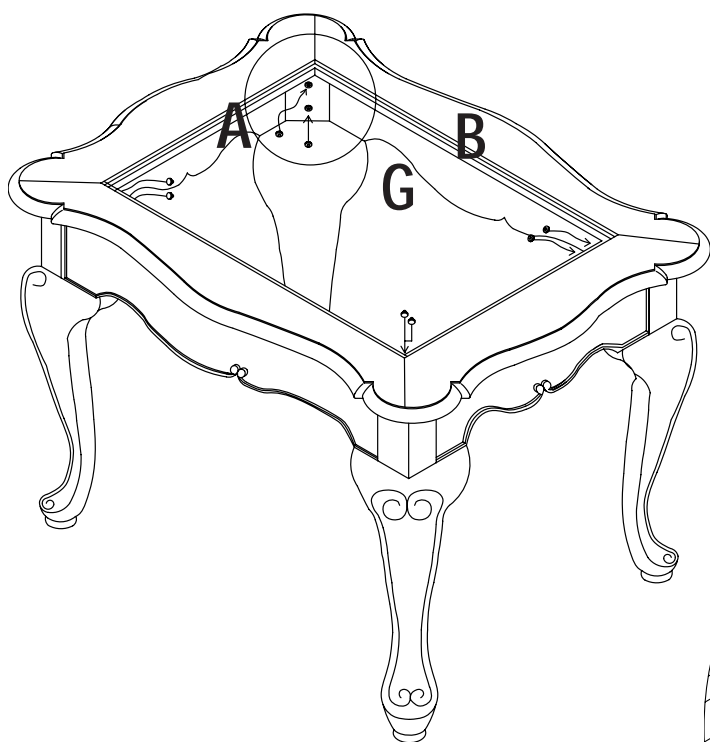
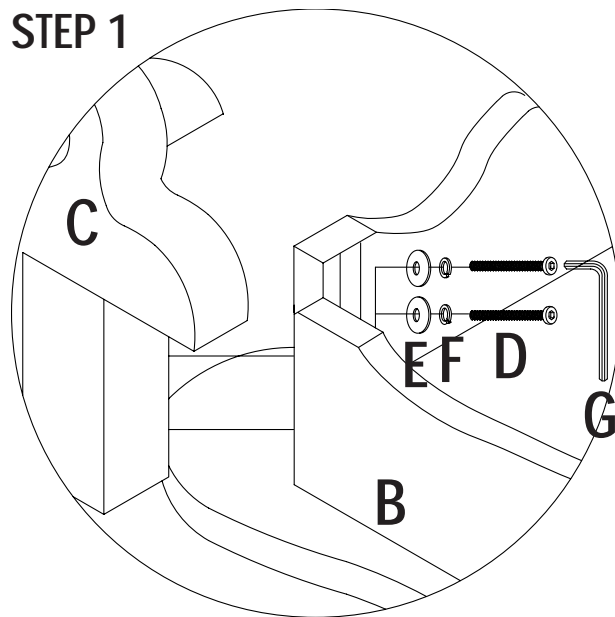

STEP 2

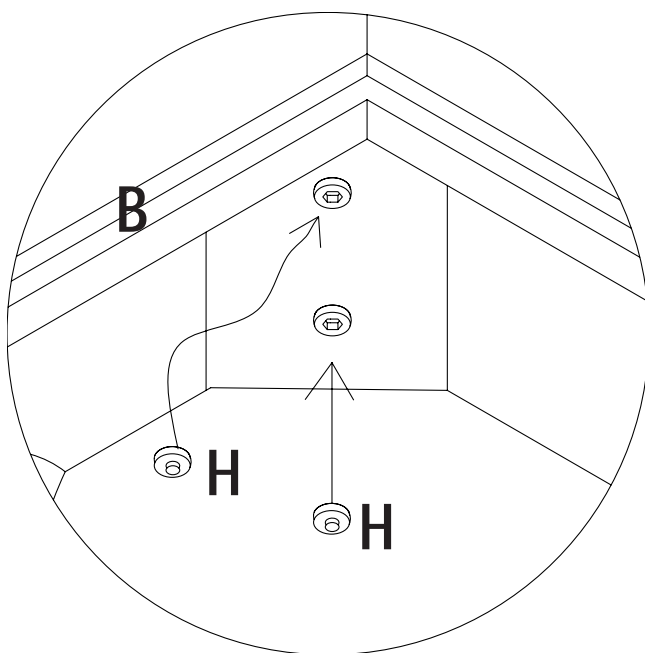

**STEP 3**

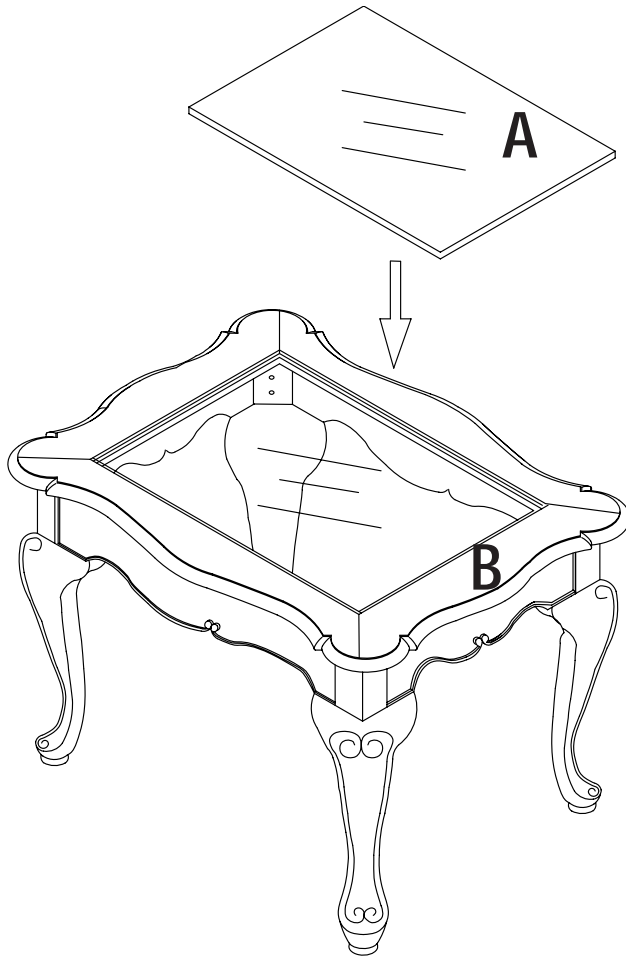

**IF YOU HAVE A PROBLEM, WE WANT TO HAVE THE OPPORTUNITY TO MAKE IT RIGHT!**

Should there be any missing or defective part(s),  
**Fax this form to (310) 841-0842**  
or call Customer Service at (800) 622-4456 or (310) 204-2224  
Have your model number and part code letter handy.

**MODEL NO. 450-210**

© 2005 Powell

Part Letter      Description      Quantity

Name \_\_\_\_\_  
Address \_\_\_\_\_

Daytime Phone (    ) \_\_\_\_\_  
Reason for replacement \_\_\_\_\_

Place of purchase \_\_\_\_\_