

Thank you for purchasing this Powell product. We want to make sure it is complete and to your satisfaction. Please check all packing material carefully for small parts which may have come loose inside the carton during shipment. Hardware can be identified by bright red packaging, Separate, identify, and count all parts and hardware to make sure they match with the illustrations herein and are all present. If any part(s) are missing or defective please contact Powell Customer Service. Contact information is given at the bottom of these instructions. If you feel the item is defective beyond a resolution with part replacements, please return this product with your receipt to the place of purchase. If purchased from an internet retailer, please contact their customer service department. Photo's and additional information may be requested to validate the claim. Product is not to be returned to the Powell Company under any circumstance unless authorized by the Powell Company or an authorized dealer or representative. Thank you.

ATTENTION: SOME LETTERED PARTS LISTED ON THE INSTRUCTION SHEET MAY NOT BE IN PARTS BAG AS THEY MAY ALREADY BE ASSEMBLED. CAREFULLY CHECK PARTS AND PACKING MATERIALS PRIOR TO ORDERING REPLACEMENTS.

Tools Required for assembly: Allen Wrench (included).

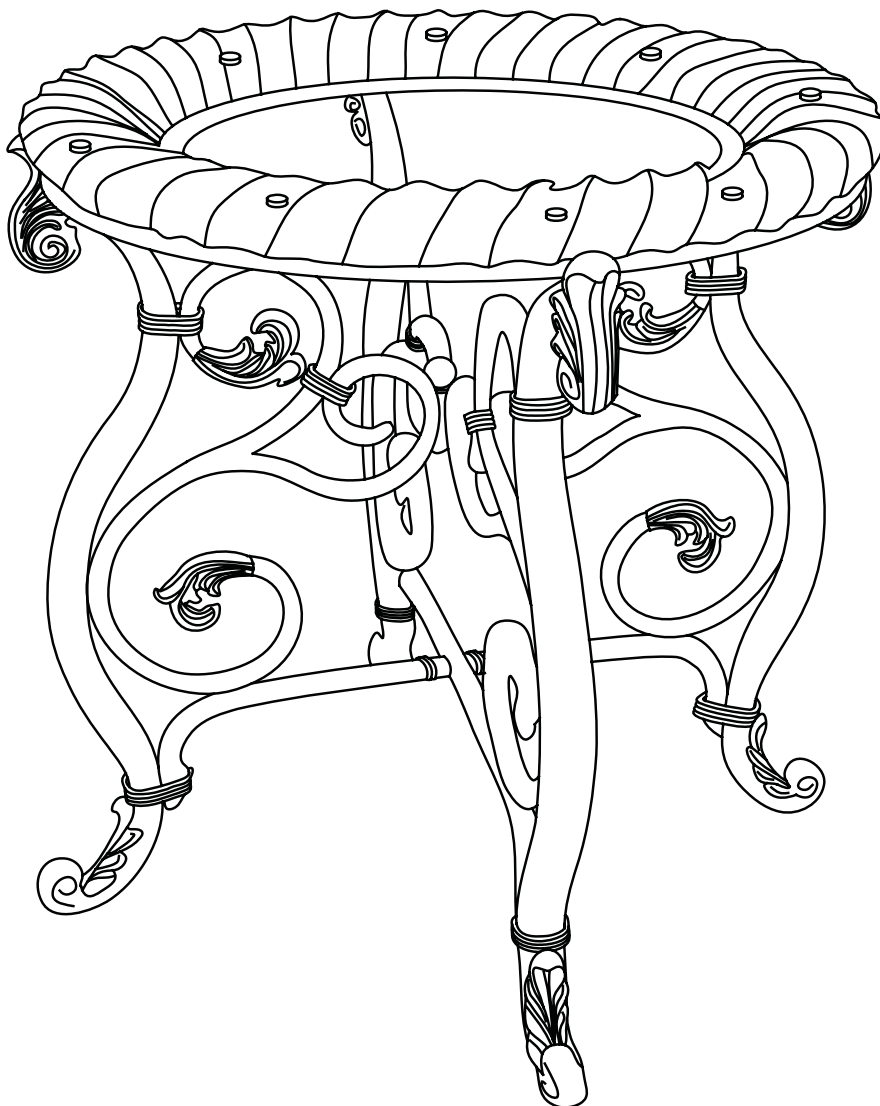

PARTS

- (A) TOP FRAME
- (B) LARGE SIDE PANEL
- (C) UPPER SIDE PANEL
- (D) LOWER SIDE PANEL
- (E) FINIAL
- (F) ADJUSTABLE FEET (4)

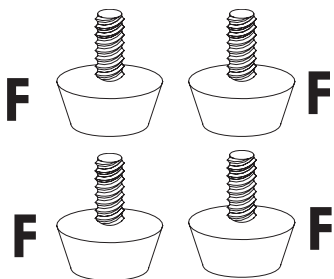
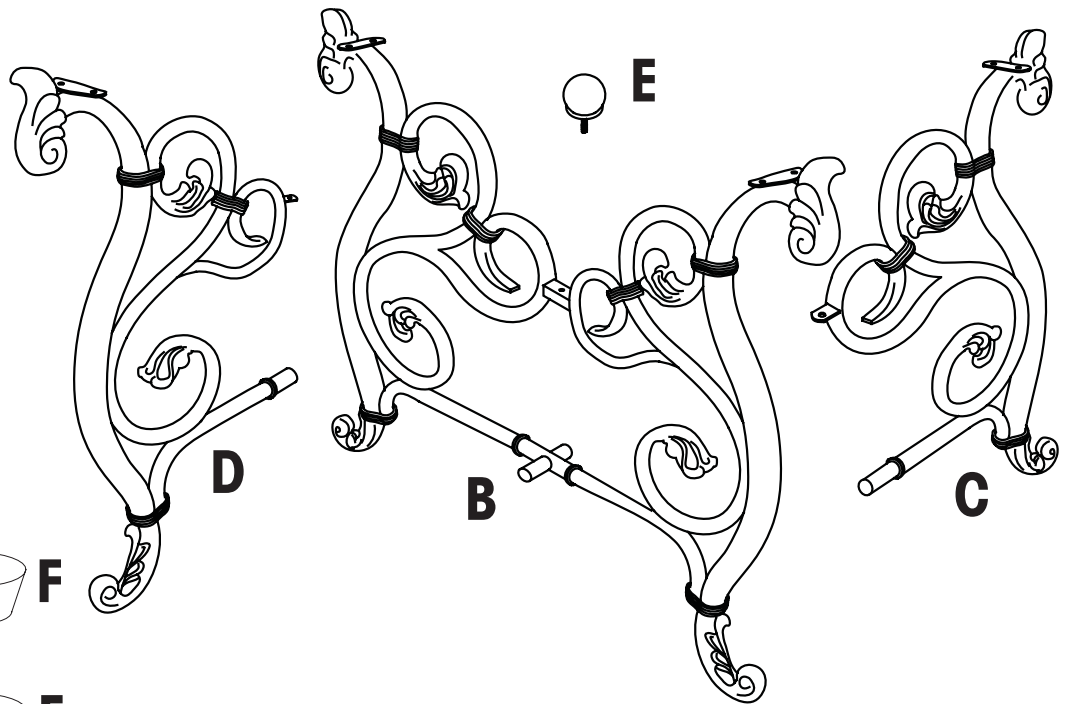
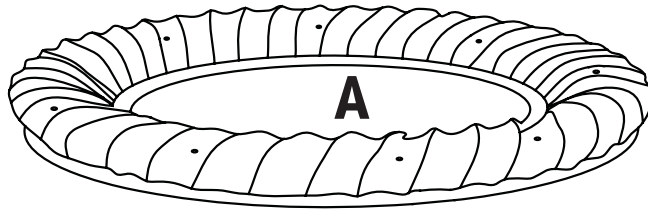

HARDWARE

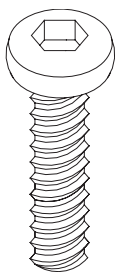

G
(8 PCS)

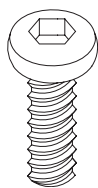

H
(2 PCS)



I
(8 PCS)



J
(8 PCS)



K
(8 PCS)

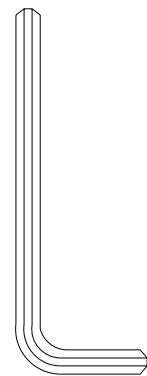

L
(1 PC)

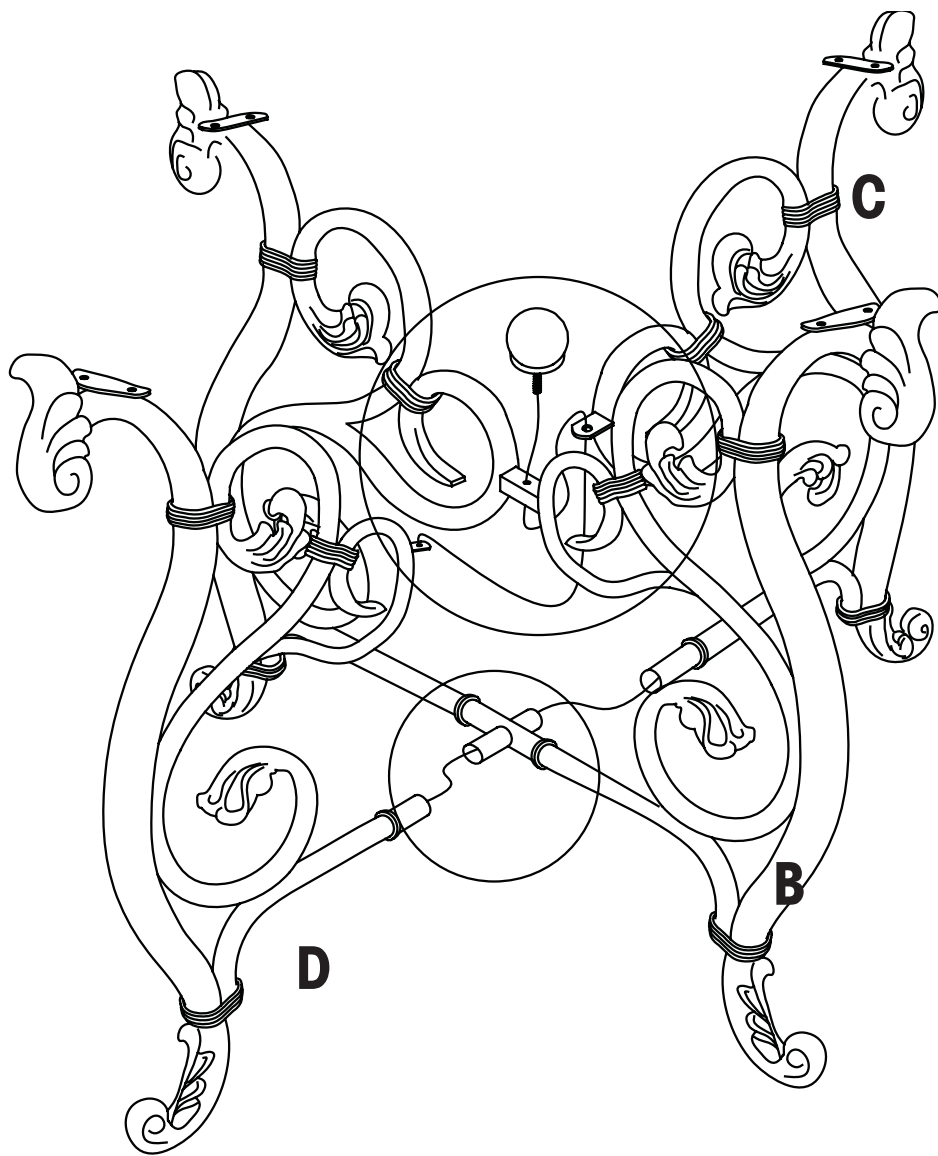

STEP 1

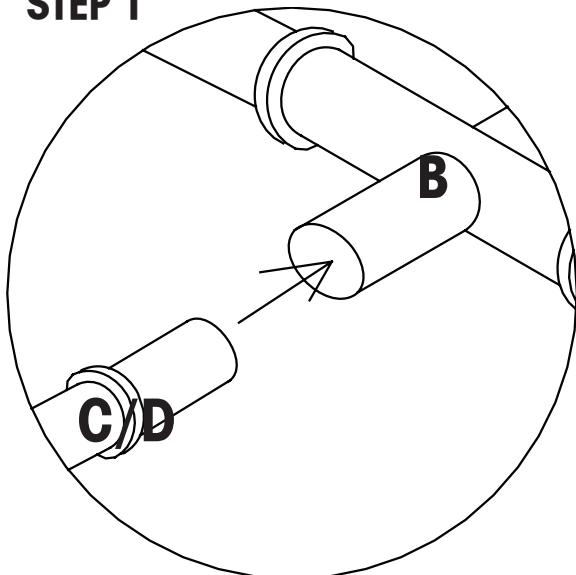

STEP 2

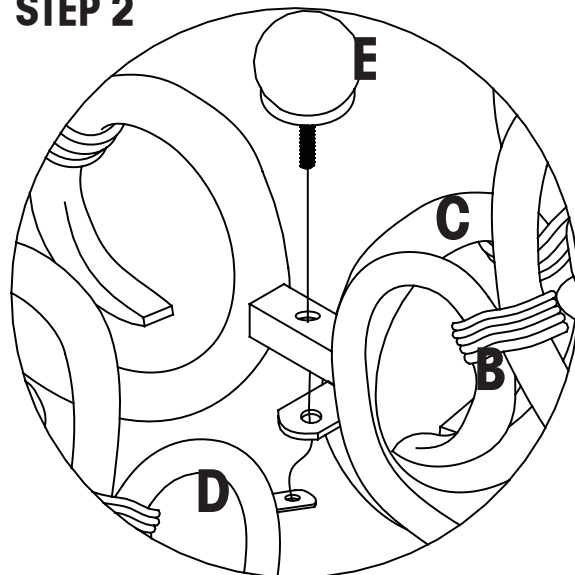

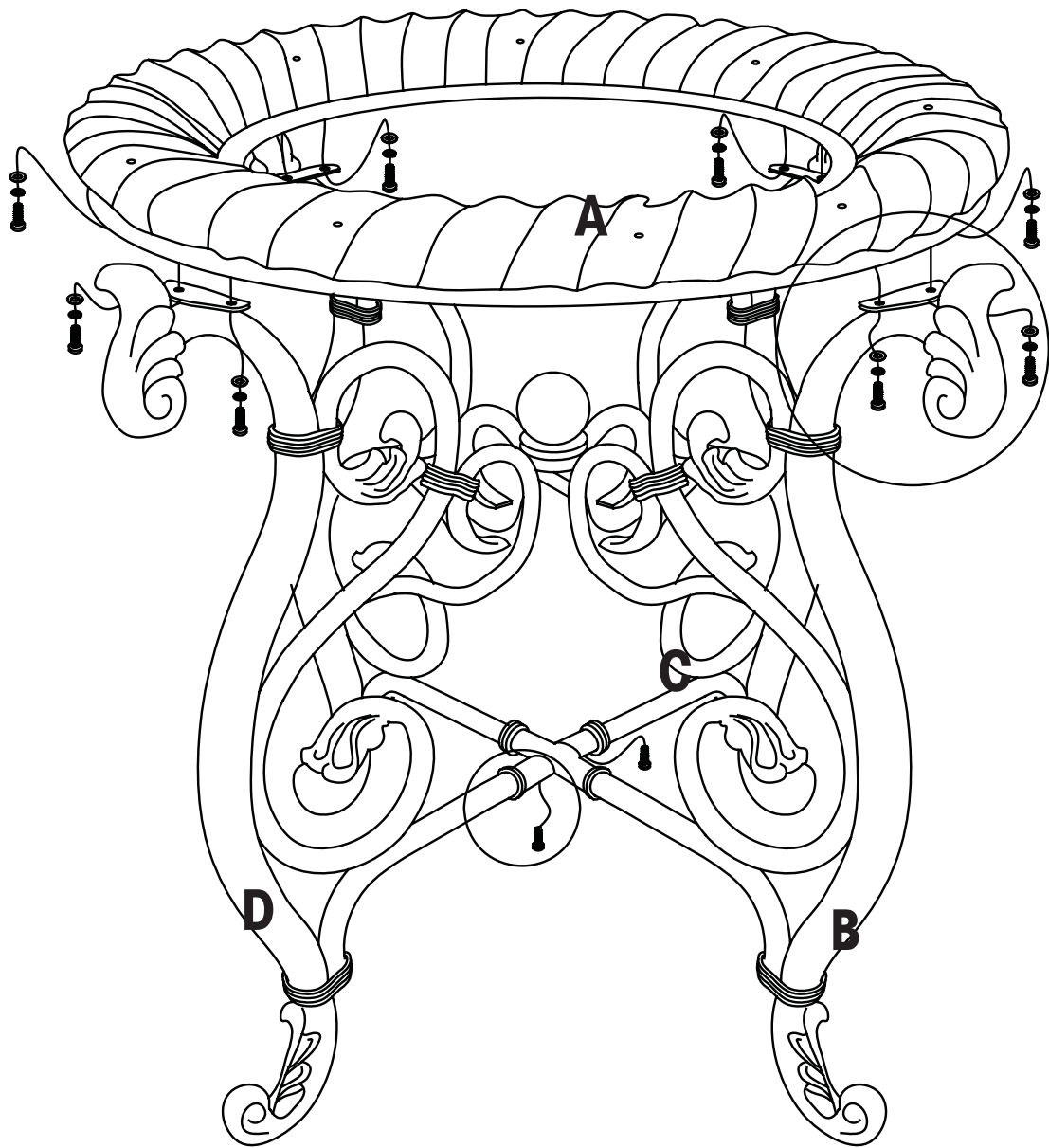

STEP 3

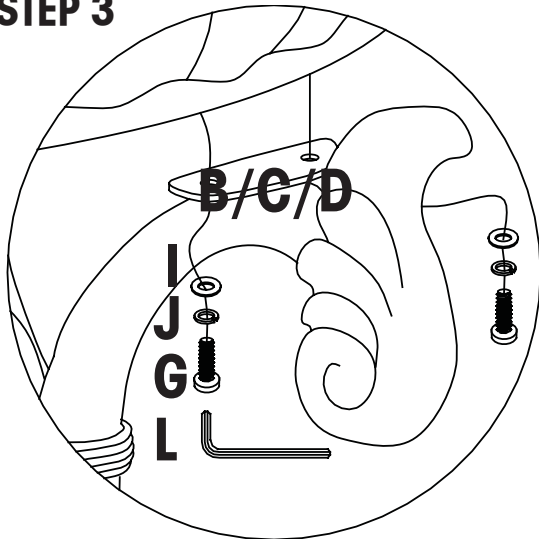

STEP 4

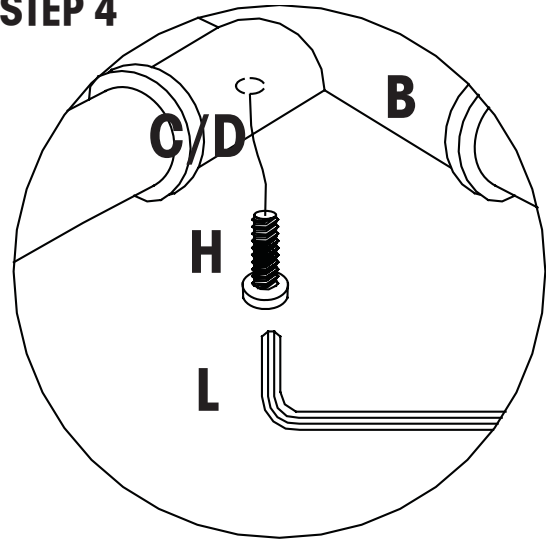

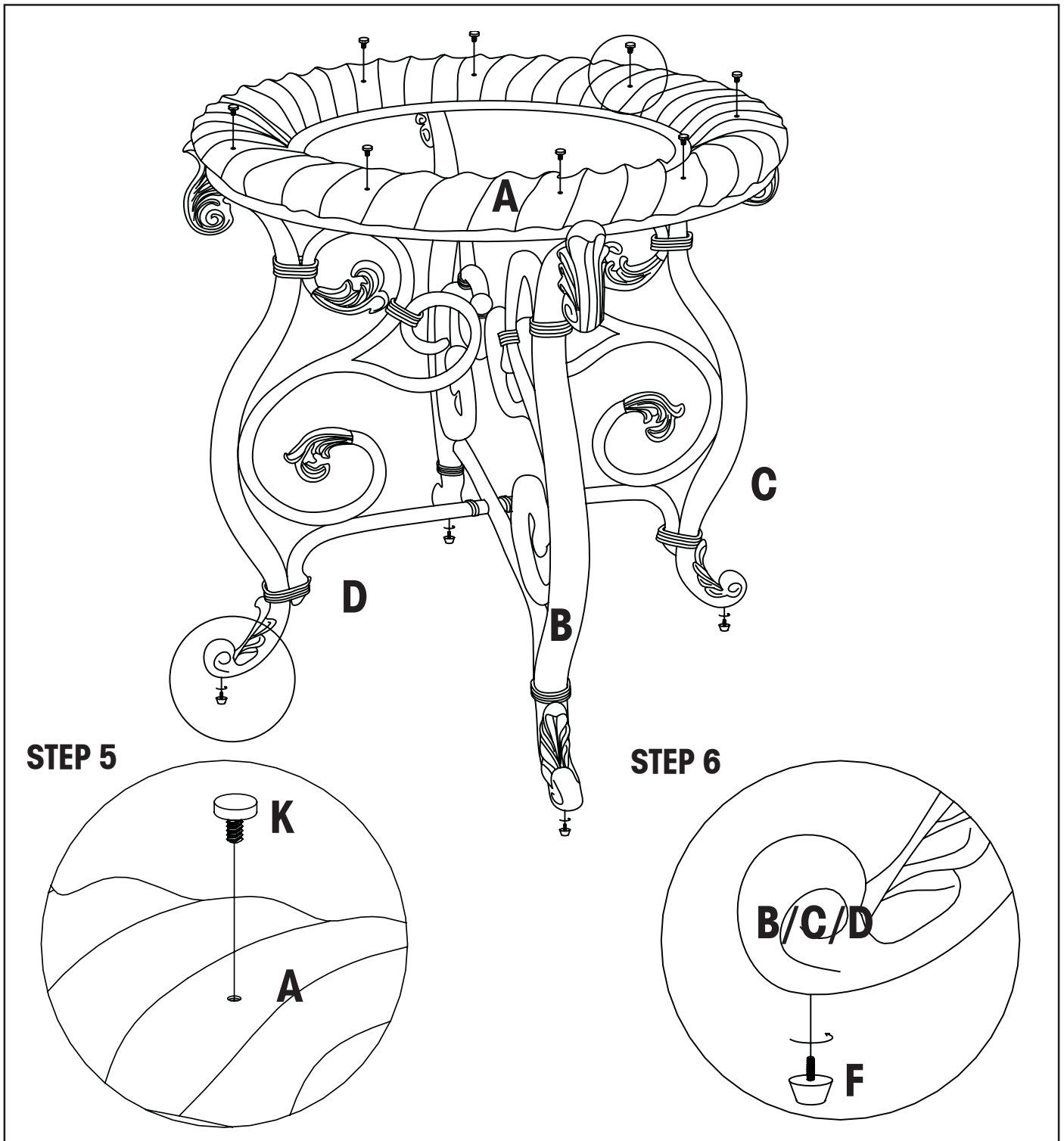

MODEL NO. 275-410

Should there be any missing or defective part(s), **place your part order on line at www.powellcompany.com**, or fax this form to (310)841-0842, or call Customer Service at (800) 622-4456, PLEASE HAVE THE MODEL NUMBER, PART CODE AND FACTORY CODE IDENTIFIED

Part Letter _____	Quantity _____	Name _____
_____	_____	Address _____
_____	_____	City _____ State _____ Zip _____
Reason for replacement _____	_____	(No Post Office Box Addresses)
_____	_____	Best contact phone number(_____) _____
Place of purchase _____	_____	Factory Code (EZ) _____
Date of purchase _____	_____	

© 2008 Powell

Made in China

Rev. 4/10/08