

4

3

2

1

NOTES:

SPECIFICATION DWG

D

D

C

C

B

B

A

A

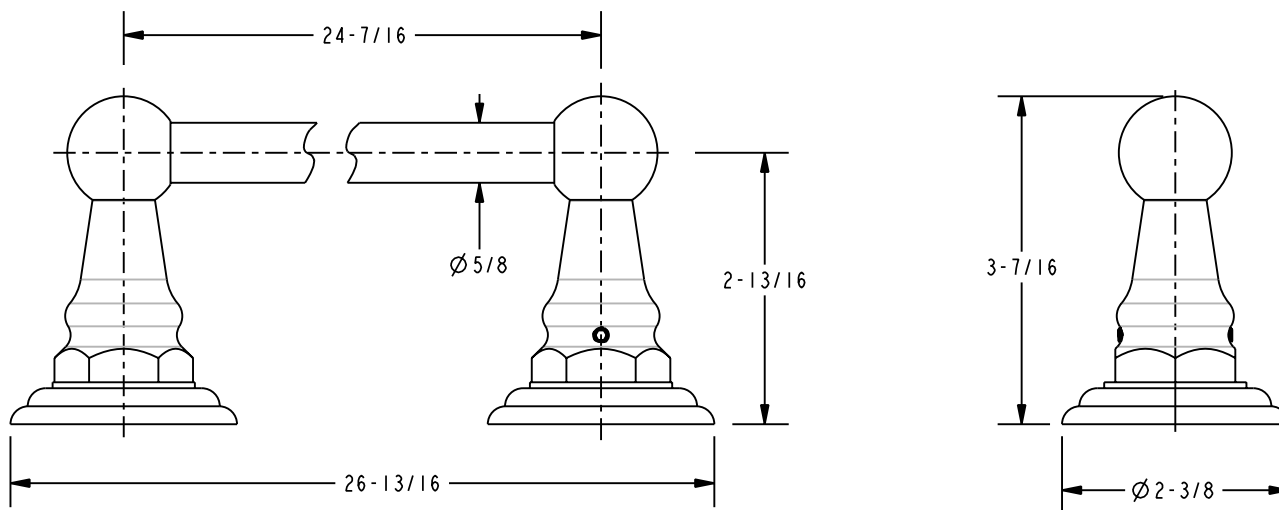

DIMENSIONS ARE IN INCHES AND AN APPROXIMATION OF A TYPICAL INSTALLATION

BRASSTECH 2001 E. CARNEGIE AVE.
 INCORPORATED SANTA ANA, CA 92705
 (949) 417-5207

24 IN. TOWEL BAR

ASSY. NO. 5921_SPEC

SCALE 0.500

REF. -

SHEET 1 OF 1

COPYRIGHT ©

4

3

2

1