

# Owner's Manual

## Ceiling Fan Installation Instructions



Total fan weight with  
light kit included

**For 5SBR56 Series Fans**

**READ AND SAVE THESE INSTRUCTIONS**

**MONTE CARLO**  
Quality Ceiling fans



# Installation

## SAFETY TIPS

**WARNING: TO REDUCE THE RISK OF FIRE, ELECTRIC SHOCK, OR INJURY TO PERSONS, OBSERVE THE FOLLOWING: READ AND SAVE THESE INSTRUCTIONS**

1. Installation work and electrical wiring must be done by qualified person(s) in accordance with applicable codes and standards (ANSI/NFPA 70-1999), including fire-rated construction.
2. Use this unit only in the manner intended by the manufacturer. If you have any questions contact the manufacturer.
3. After making the wire connections, the wires should be spread apart with the grounded conductor and the equipment-grounding conductor on one side of the outlet box and ungrounded conductor on the other side of the outlet box.
4. Before you begin installing the fan, Switch power off at Service panel and lock service disconnecting means to prevent power from being switched on accidentally. When the service disconnecting means cannot be locked, securely fasten a prominent warning device, such as a tag, to the service panel.
5. Be cautious! read all instructions and safety information before installing your new fan. Review the accompanying assembly diagrams.
6. When cutting or drilling into wall or ceiling, do not damage electrical wiring and other hidden utilities.
7. Make sure the installation site you choose allows the fan blades to rotate without any obstructions. Allow a minimum clearance of 7 feet from the floor to the trailing edge of the blade.
8. **WARNING – Risk of fire, electric shock, or personal injury,** The fan in this box may be either directly supported from a structural framing member of a building and/or may be mounted to an outlet box marked acceptable for fan support of 31.8 kg. (70 lbs.) or less. Most outlet boxes commonly used for the support of luminaires may not be acceptable for fan support and may need to be replaced. Consult a qualified electrician if in doubt.
9. Do not bend blade holders during installation to motor, balancing or during cleaning. Do not insert foreign object between rotating blades.
10. Attach the mounting bracket using only the hardware supplied with the outlet box.
11. To reduce the risk of fire or electric shock, do not use this fan with any solid state fan speed control device, or variable speed control.
12. If this unit is to be installed over a tub or shower, it must be marked as appropriate for the application.
13. NEVER place a switch where it can be reached from a tub or shower.
14. The combustion airflow needed for safe operation of fuel-burning equipment may be affected by this unit's operation. Follow the heating equipment manufacturer's guideline safety standards such as those published by the National Fire Protection Association (NFPA), and the American Society for Heating, Refrigeration and Air Conditioning Engineers (ASHRAE) and the local code authorities.
15. Before servicing or cleaning unit, Switch power off at Service panel and lock service disconnecting means to prevent power from being switched on accidentally. When the service disconnecting means cannot be locked, securely fasten a prominent warning device, such as a tag, to the service panel.

## TOOLS REQUIRED

Phillips Screwdriver

Wire Cutters

Pliers

Step Ladder



**1**  
Before you begin installing the fan, Switch power off at Service panel and lock service disconnecting means to prevent power from being switched on accidentally. When the service disconnecting means cannot be locked, securely fasten a prominent warning device, such as a tag, to the service panel.

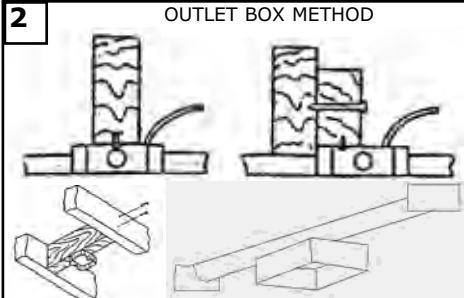

**2** OUTLET BOX METHOD  
**Warning**-Risk of fire, electric shock, or personal injury. The fan in this box may be either directly supported from a structural framing member of a building and/or may be mounted to an outlet box marked acceptable for fan support of 31.8 kg (70 lbs) or less. Most outlet boxes commonly used for the support of luminaires may not be acceptable for fan support and may need to be replaced. Consult a qualified electrician if in doubt.



**3**  
Remove Safety bar from mounting bracket by loosening screws, sliding bar to side, and lifting it off the 2 screws.



**4**  
Remove the 4 screws attaching the Mounting neck the mounting plate. Retain the 4 screws for re-assembly.

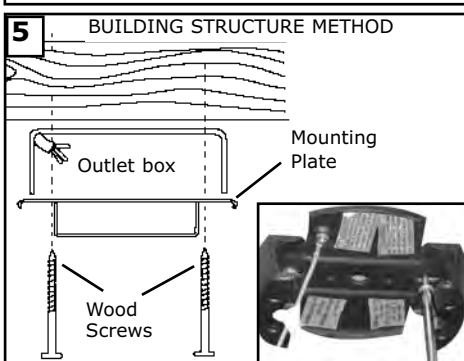

**5** BUILDING STRUCTURE METHOD  
Secure mounting plate directly to a joist from the building structure via the two knock out holes on the outlet box. Use only the appropriate wood screws and washers included with your fan. Caution: Wood screws must go through into the building joist.



**6** FAN BRACE AND BOX METHOD  
Install the mounting Plate to approved fan brace and box method. Use only the hardware provided with the fan brace and box.

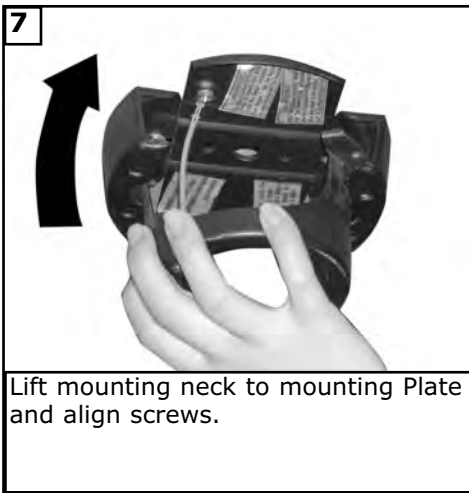

7 Lift mounting neck to mounting Plate and align screws.

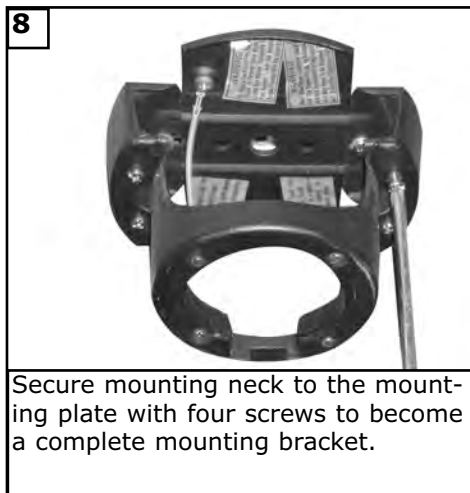

8 Secure mounting neck to the mounting plate with four screws to become a complete mounting bracket.

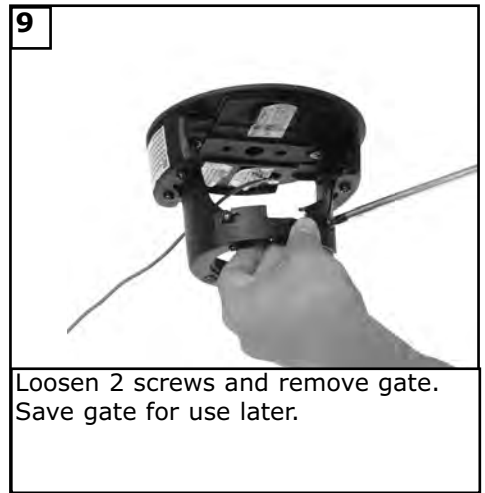

9 Loosen 2 screws and remove gate. Save gate for use later.

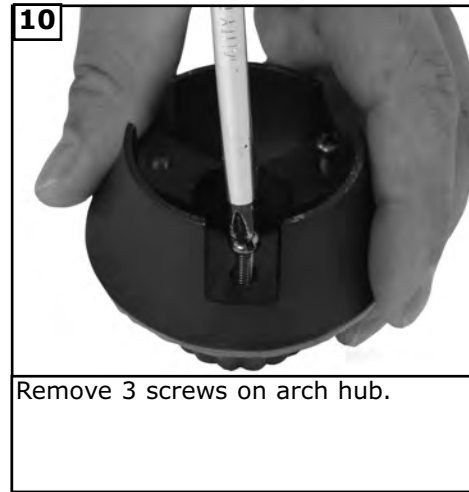

10 Remove 3 screws on arch hub.



11 Use 3 screws removed to attach arch brackets to arch hub.

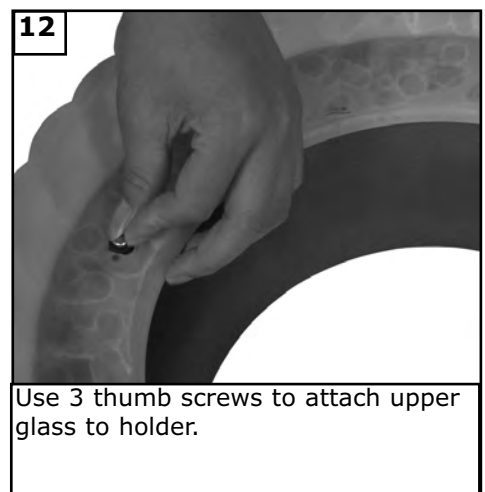

12 Use 3 thumb screws to attach upper glass to holder.



13 Install upper glass and holder to fan body.



14 Install 4 x 25 watt incandescent candleabra bulbs.



15 Loosen lock nuts and screws on yoke till you can not feel screws on inside of yoke.



16 Remove keeper from cross pin and then cross pin from yoke. Replace keeper on cross pin and save.

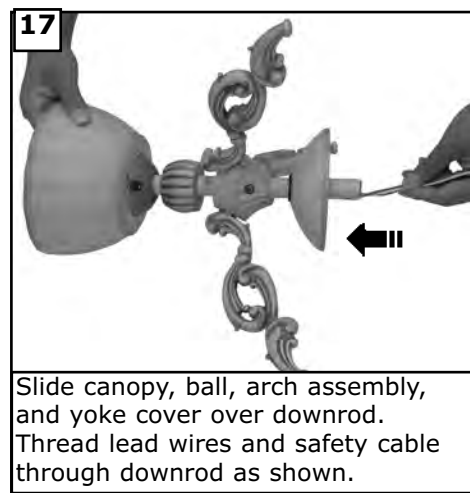

17 Slide canopy, ball, arch assembly, and yoke cover over downrod. Thread lead wires and safety cable through downrod as shown.



18 Align hole in downrod with hole in yoke and install cross pin. Install downrod assembly into yoke. Install keeper into cross pin.

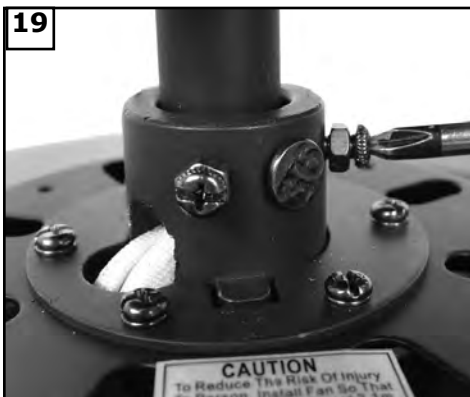

Tighten 2 downrod set screws and lock nuts.



Hang assembled fan from the mounting bracket installed to ceiling in previous step. Make sure the fan is hanging straight. Rotate fan until the tab on the Mounting bracket engages the slot on the Downrod Ball. This must be done to prevent the fan body from rotating when the blades are in motion.

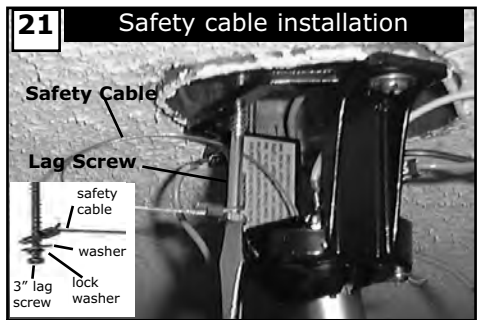

Fan and light kit combinations over 35 lbs, in both flush and downrod mode the safety cable must be installed into the house structure beams using the 3" lag screws, washers, and lock washers, provided. Make sure that when the safety cable is fully extended the lead wires are longer than the cable and no stress is placed on the lead wires.



Install remote receiver by sliding into opening in the Mounting bracket. Make sure that the dip switches on the Transmitter and the Receiver are set to the same position. See Fig 39 for remote operation

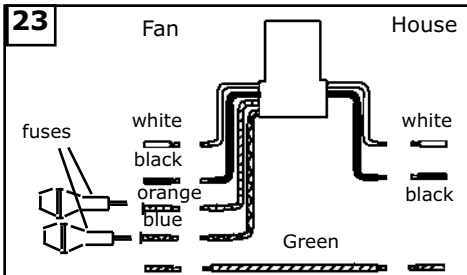

Make wiring connections as indicated above. White from fan to white from remote marked N. Orange from fan to Orange from remote marked Light/up. Blue from fan to blue from remote marked down light. Black from fan to Black from remote marked L. White from house to white from remote marked AC N. Black from house to Black from remote marked AC L. Connect all green ground wires to Ground wire from House.



Make wire connections to power source using wire nuts provided. Make sure that no filaments are outside of the wirenut. After making the wire connections, the wires should be spread apart with the grounded conductor and the equipment-grounding conductor on one side of the outlet box and ungrounded conductor on the other side of the outlet box.



Re-install safety bar removed in step. 3 by placing safety bar on screws, sliding into place, and tightening the 2 screws.

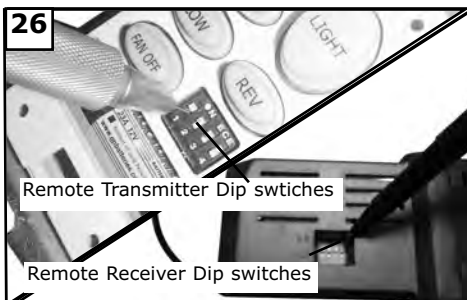

Set dip switches on the Remote Transmitter and Remote Receiver to the same settings. This must be done so the units will communicate properly. If you have other fans you can set to control from one transmitter by setting both receivers the same as the transmitter. If you have more than one fan with remote. You can set the dip switches to different positions to have separate control.

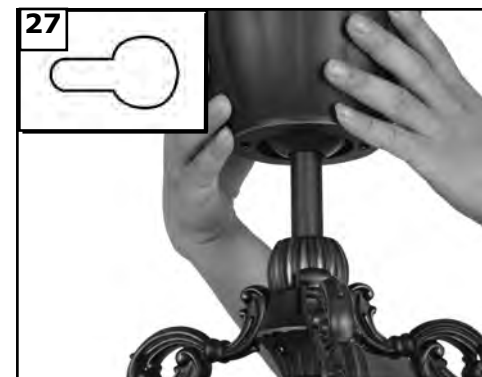

Lift Canopy to ceiling aligning the key hole slots with the screws on the bottom of the Mounting bracket. Rotate the canopy Counter Clockwise to lock in place. Tighten the screws to secure the Canopy. See inset for Keyhole shape

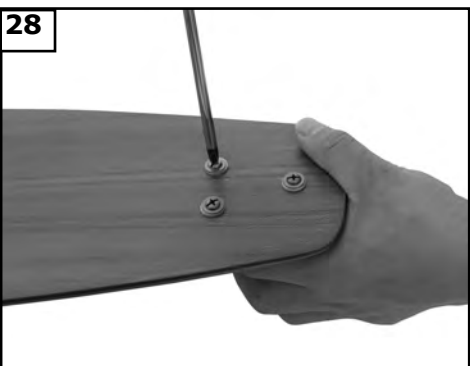

Place blade arms onto the other side of the blade and aligning holes. Insert screws with fabric washers through the holes and tighten securely.



Install all 5 fan blade assemblies to the motor as shown above. Tighten screws securely.



Loosen 2 of the 3 screws that will hold the light kit. Remove the screw that is associated to the closed hole on the light kit.



**31**  
 Plug white wire from fan to white wire from light kit. Then plug black wire from fan to black wire from light kit.

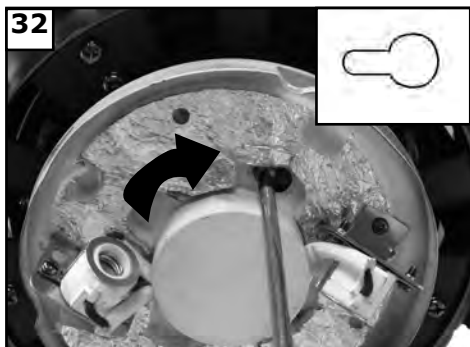

**32**  
 Lift light kit to the fan motor assembly. Align the 3 screws with the key hole slot holes in the light kit (see inset). Rotate the light kit as shown. Then install the screw removed in the previous step through the closed hole. Tighten all 3 screws securely.



**33**  
 Install the 2x50 watt halogen bulbs. Do not touch bulb surface as oily residue from skin can cause the bulb to explode.



**34**  
**This step is for glass replacement only.** Remove 1 glass holder and place glass in decorative body of light kit. Replace glass holder to hold glass in place.

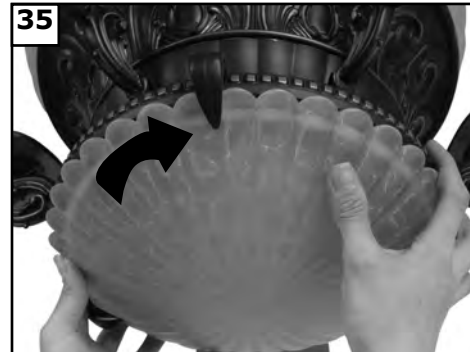

**35**  
 Twist light kit into place by turning direction of arrow.



**36**  
 Remove cover by snapping off from top or bottom. Install 12V battery into wall remote. Duracell MN21 / Eveready A23 / GP 23A all 12V.



**37**  
 Attach cover of remote by placing over buttons and snapping into place.

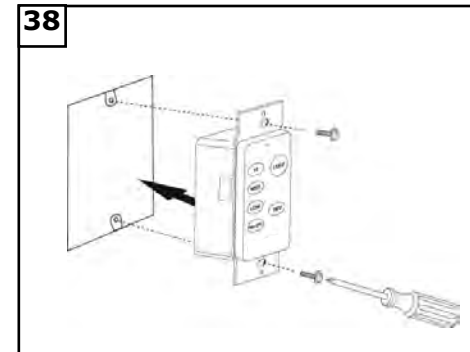

**38**  
 Install wall control unit to outlet box using machine screws provided.

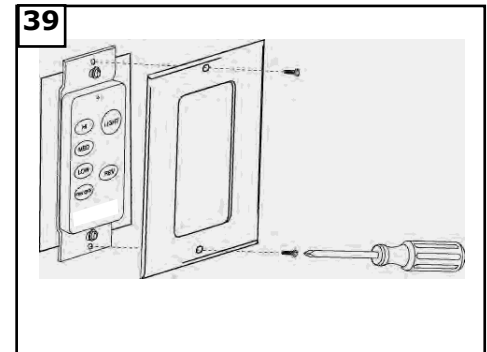

**39**  
 Attach front cover to wall control with screws provided.

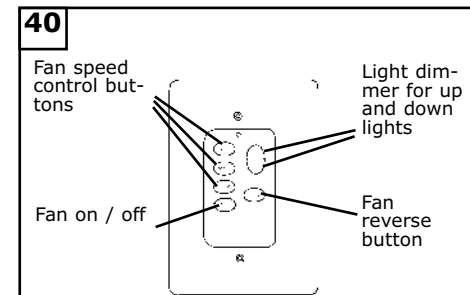

**40**  
 To control fan speed select from High, Medium or low speed buttons. To turn the fan off press the Fan on / off button. To dim upper lights press and hold U/L button. To dim Lower lights press and hold D/L button. To turn off either up or down light press and quickly release either U/L or D/L button. Press button marked REV to reverse the rotation direction of the fan blades

# Trouble Shooting

If you have difficulty operating your new ceiling fan, it may be the result of incorrect assembly, installation, or wiring. In some cases, these installation errors may be mistaken for defects. If you experience any faults, please check this Trouble Shooting Chart. If a problem cannot be remedied, or you are experiencing difficulty in installation, please call our Customer Service Center at the number printed on your parts list insert sheet.

**Warning: Before servicing or cleaning unit, Switch power off at Service panel and lock service disconnecting means to prevent power from being switched on accidentally. When the service disconnecting means cannot be locked, securely fasten a prominent warning device, such as a tag, to the service panel.**

1. If fan does not start:

1. Check main and branch circuit fuses or circuit breakers.
2. Check line wire connections to fan and switch wire connections in switch housing.
3. Check to make sure the dip switches from the transmitter and receiver are set on the same frequency.

**CAUTION: Make sure main power is turned off.**

2. If fan sounds noisy:

1. Check to make sure all screws in motor housing are snug (not over tightened).
2. Check to make sure the screws which attach the fan blade holder to the motor are tight.
3. Check to make sure wire nut connectors in switch housing are not rattling against each other or against the interior wall of the switch housing.

**CAUTION: Make sure main power is turned off before entering switch housing.**

4. Some fan motors are sensitive to signals from Solid State variable speed controls. **DO NOT USE a Solid State variable speed control.**
5. Allow "break-in" period of 24 hours. Most noises associated with a new fan will disappear after this period.

3. If fan wobbles:

1. Make sure that the ridge of the canopy engages the notch in the downrod ball.
2. Check that all blades are screwed firmly into blade holders.
3. Check that all blade holders are tightened securely to motor.
4. Make sure that canopy and mounting bracket are tightened securely to ceiling junction box and junction box is mounted firmly to ceiling joist.
5. Most fan wobble problems are caused when blade levels are unequal. Check this level by selecting a point on the ceiling above the tip of one of the blades. Measure this distance from blade tip to ceiling. Keeping measure within 1/8", rotate the fan until the next blade is positioned for measurement. Repeat for each blade. If all blade levels are not equal, you can adjust blade levels by the following procedure. To adjust a blade tip down, insert a washer (not supplied) between the blade and blade holder at the screw closest to the motor. To adjust a blade tip up, insert washer (not supplied) between the blade and blade holder at the two screws farthest from the motor. Reverse the position of the washer if blades mount from top of blade.
6. If blade wobble is still noticeable, interchanging two adjacent (side by side) blades can redistribute the weight and possibly result in smoother operation.

4. If light does not work:

1. Check wire from fan to make sure it is connected to hot wire from house.
2. Check for loose or disconnected wires in fan switch housing.
3. Check for loose or disconnected wires in light kit.
4. Check for faulty light bulbs.

**CAUTION: Make sure main power is turned off before entering switch housing.**  
**WARNING: Before attempting to replace the fuse make sure the main power is turned off to the fan. Replace only with 3 amp fuse.**



## MONTE CARLO

Customer Service Center:  
740 S.W. Loop 820, Suite 110  
Fort Worth, Texas 76115  
1-800-519-4092

REV. 1

2/4/04

Step 8 in safety tips & step 2 page 2 & battery remote