

NAOMI Pinza

Designer
Yaacov Kaufman - 2001

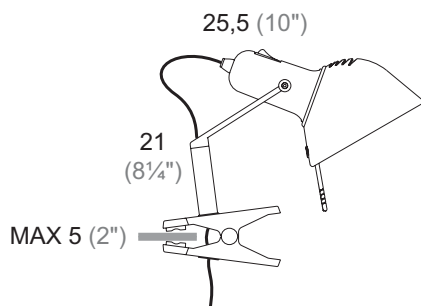

Lampada in alluminio orientabile con attacco a pinza e cavo di alimentazione da 3m. La pinza può essere impiegata su superfici di spessore min. 10mm e max 30mm.



Adjustable Clip-on lamp in aluminium, with 3m (9.8" inch) long feeding cable. The clip is suitable for surfaces between 10mm (3/8" inch) and 30mm (1").

Schwenkbare Leuchte aus Aluminium mit Zwingbefestigung und Leitungskabel 3m lang. Die Zwinne kann auf Flächen mit Stärke von 10mm bis max 30mm verwendet werden.



Col. 08

Alluminio anodizzato
Anodised aluminium
Eloxiertes Aluminium

Denominazione - Name - Name	Naomi Pinza (cod. 328)
Certificazioni - Certificated - Prüfzeichen	
Normative - Norms - Normen	EN 60-598 (CEI 34-21)
Lampadina - Light sources - Leuchtmittel	MAX 60W I - MAX 75W HAL - E27
Versioni - Available - Versionen	230V (Europe) - 110V (USA - Japan) - 240V (England)
Classe di isolamento - Insulation Class - Isolierungsklasse	II
Classe di protezione - Protection Class - Protektionsgrad	IP20
Imballo - Packaging - Verpackung	 0,010m ³ - 0,700Kg

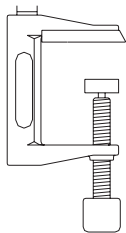

Cod. 112
Morsetto
Clamp-on
Tischklemme

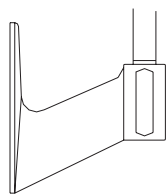

Cod. 113
Attacco parete
Wall attachment
Wandbefestigung

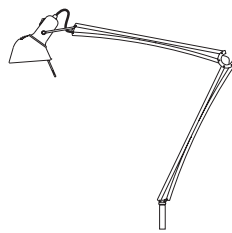

Cod. 300
Naomi 2 corpo
Naomi 2 Körper
Naomi 2 body

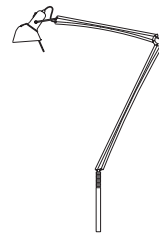

Cod. 305
Naomi 2 corpo
Naomi 2 Körper
Naomi 2 body



Cod. 310
Base
Base
Fuss

Actions

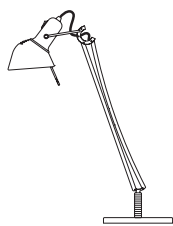

Cod. 320
Naomi 1

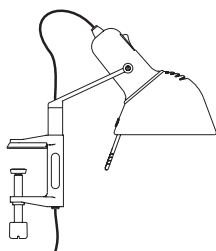

Cod. 329
Naomi Morsetto

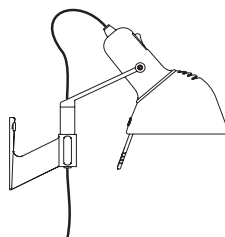

Cod. 330
Naomi Parete

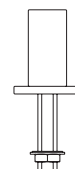

Cod. 332
Fissaggio tavolo
Table mount
Tischbefestigung

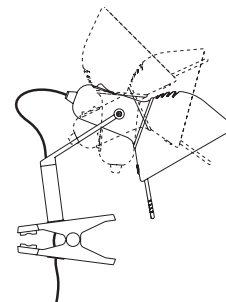

Notes
