

NAOMI Parete

Designer
Yaacov Kaufman - 2001

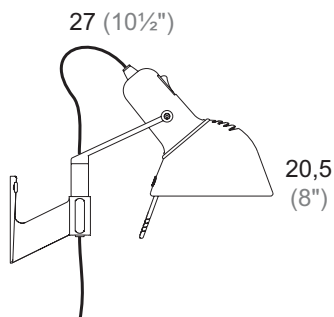

Lampada in alluminio orientabile con attacco a parete e cavo di alimentazione da 3m.



Adjustable wall lamp in aluminium, with 3m (9.8" inch) long feeding cable.

Schwenkbare Leuchte aus Aluminium mit Wandbefestigung und Leitungskabel 3m lang.



Col. 08

Alluminio anodizzato
Anodised aluminium
Eloxiertes Aluminium

Denominazione - Name - Name	Naomi Parete (cod. 330)
Certificazioni - Certificated - Prüfzeichen	
Normative - Norms - Normen	EN 60-598 (CEI 34-21)
Lampadina - Light sources - Leuchtmittel	MAX 60W I - MAX 75W HAL - E27
Versioni - Available - Versionen	230V (Europe) - 110V (USA - Japan) - 240V (England)
Classe di isolamento - Insulation Class - Isolierungsklasse	II
Classe di protezione - Protection Class - Protektionsgrad	IP20
Imballo - Packaging - Verpackung	 0,010m ³ - 0,700Kg

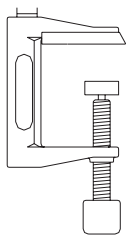

Cod. 112
Morsetto
Clamp-on
Tischklemme

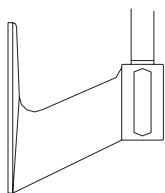

Cod. 113
Attacco parete
Wall attachment
Wandbefestigung

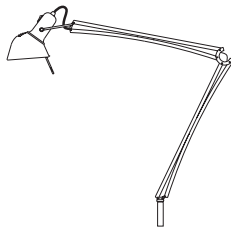

Cod. 300
Naomi 2 corpo
Naomi 2 Körper
Naomi 2 body

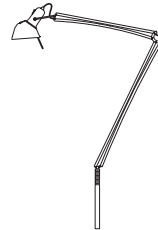

Cod. 305
Naomi 2 corpo
Naomi 2 Körper
Naomi 2 body



Cod. 310
Base
Base
Fuss

Actions

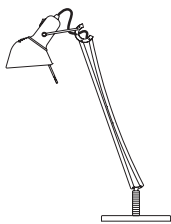

Cod. 320
Naomi 1

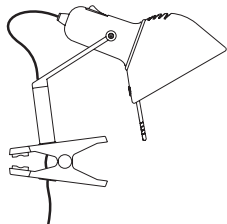

Cod. 328
Naomi Pinza

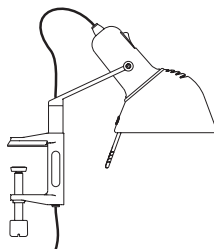

Cod. 329
Naomi Morsetto

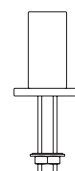

Cod. 332
Fissaggio tavolo
Table mount
Tischbefestigung

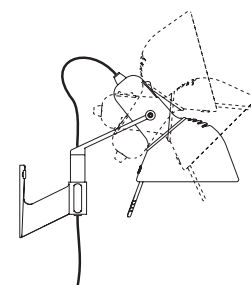

Notes
