



Assembly Instructions & Parts Identification

Model Name : 888-BS800KD







Prior to assembling, please read through the instructions carefully and verify that you have received all parts listed in key below. Remove all packing materials, including wrapping, staples, and straps. To prevent scratches during assembly, place all wooden pieces on a flat soft surface, such as a carpet or rug. Thank you for purchasing this quality piece of furniture. Please handle with care, as small parts may have come loose during shipment.

CAUTION: DO NOT FULLY TIGHTEN NUTS AND BOLTS UNTIL ALL ARE IN PLACE. DO NOT OVER-TIGHTEN NUTS AND BOLTS, AS IT MAY CAUSE THREAD DAMAGE. KEEP ALL SMALL PIECES OUT OF REACH OF CHILDREN.

PART LIST

NO.	PART NO.	DESCRIPTION	Q"TY
1	888-BS800KDP40	CHAIR BACK	1 PC
2	888-BS800KDP41	COMPLETE SEAT	1 PC
3	888-BS800KDP42	RIGHT FACING LEG	1 PC
4	888-BS800KDP43	LEFT FACING LEG	1 PC
5	888-BS800KDP44	RIGHT FACING STRETCHER	1 PC
6	888-BS800KDP45	LEFT FACING STRETCHER	1 PC
7	888-BS800KDP49	FRONT STRETCHER	1 PC
8	888-BS800KDP01F	FLOOR GLIDE	4PCS

HARDWARE LIST

NO.	PART NO.	FIGURE	DESCRIPTION	Q"TY
A	888-BS800KDP46		ALLEN KEY	1 PC
B			Ø 5/16" * 3/4" METAL SCREW	8 PCS
C			Ø 5/16" * 2 1/4" METAL SCREW	8 PCS
D			Ø 5/16" * 2 3/4" METAL SCREW	4 PCS
E			WOOD DOWELS	14PCS
F			Ø 5/8" * 1-1/2" DOWELS	12PCS

Carefully lay chair back flat on a soft surface and affix complete seat to chair back

Step 1

- (a) Insert E wood dowel into chair back then using Allen key. Insert D screw through seat box into chair back
- (b) Insert B screws through seat box into chair back.

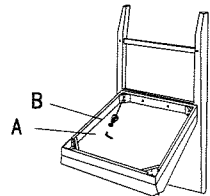
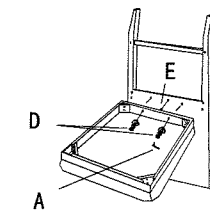

Step 2

Insert E wood dowels & F screw into chair back and front leg, then attach C screw using Allen key to thread through the corners of the seat rim and into front leg. Again, do not fully tighten.

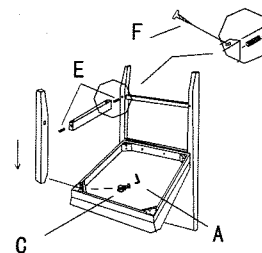

Step 3

Thread in F screw into front stretcher and side stretcher.

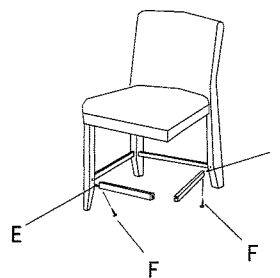

JOFRAN INC.

Assembly Instructions & Parts Identification

Model Name : 888-BS800KD

Prior to assembling, please read through the instructions carefully and verify that you have received all parts listed in key below. Remove all packing materials, including wrapping, staples, and straps. To prevent scratches during assembly, place all wooden pieces on a flat soft surface, such as a carpet or rug. Thank you for purchasing this quality piece of furniture. Please handle with care, as small parts may have come loose during shipment.

CAUTION: DO NOT FULLY TIGHTEN NUTS AND BOLTS UNTIL ALL ARE IN PLACE. DO NOT OVER-TIGHTEN NUTS AND BOLTS, AS IT MAY CAUSE THREAD DAMAGE. KEEP ALL SMALL PIECES OUT OF REACH OF CHILDREN.

STEP4

Place the front leg in place, attach C screw using A allen key to thread through the corner of the seat rim. Insert E wood dowels and thread in F screw into front stretcher and side stretcher, don't fully tighten.

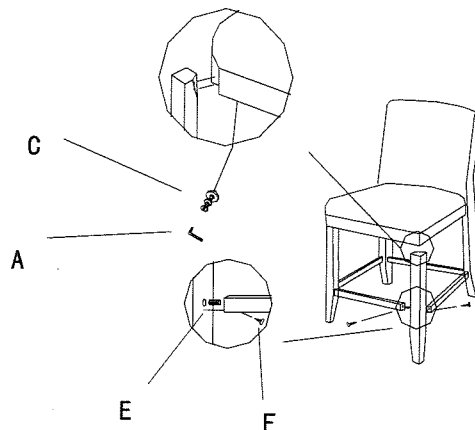

STEP5

Bring chair to upright position, place on the flat floor to balance, then tighten all connections securely. This will level your chair.

