

Granite

INSTALLATION INSTRUCTIONS

The few tools required are not specialized or expensive. All are probably in your tool box or your neighbors.

Here is what you will need:

1. Flashlight
2. Long thin screwdriver
3. Tube of silicone sealant for mounting sink
4. Yardstick
5. Two adjustable wrenches
6. Pipe wrench if steel pipe used
7. Hammer
8. Punch
9. File
10. Drill
11. Jigsaw

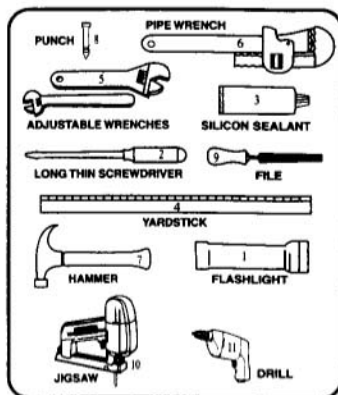

STEP ONE

Remove the Old Sink

Leave the faucet and drain outlet in place for now.

1. Shut off the water supply valves (usually under the sink)
2. Relieve pressure by opening faucet
3. Disconnect the water supply fittings from the outlet of the water supply valves
4. Disconnect the drain fitting from the waste trap
5. Remove frame or rim fasteners around underside of old sink
6. Lift out sink with faucet and drain fitting in place
7. If you are installing a new countertop go to page three for directions

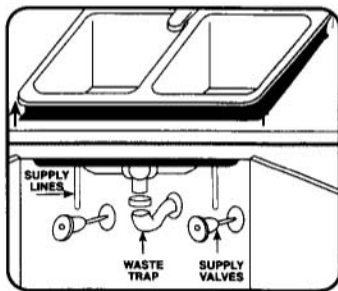

STEP TWO

Check Countertop Opening

Make sure the existing countertop cutout opening is the proper size. Simply set the new sink into the opening. The sink rim should rest evenly on the countertop. If not, a slight adjustment can be made by using a file or a greater adjustment by using a sabre saw or keyhole saw. Care should be taken not to chip or crack the laminated top by aggressive filing or sawing. After final fitting, remove the new sink from cut out.

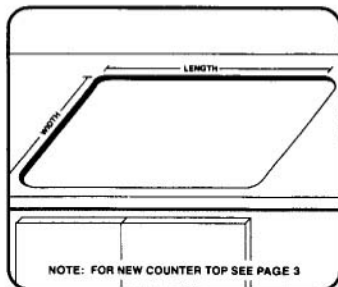

STEP THREE

Knocking out Faucet/ Accessory Holes

If your sink already has the proper number of holes needed, you can disregard this step. Place the sink upright on a stable workstation. Locate the round stickers on the ledge of the sink.

These stickers represent the locations of the partially drilled holes. (See Illustration A) Select the area you would like to install your Faucet or Accessory and with a hammer and punch, you can knock out the partially drilled holes. (See Illustration B) You will then use a file to smooth away any rough surface.

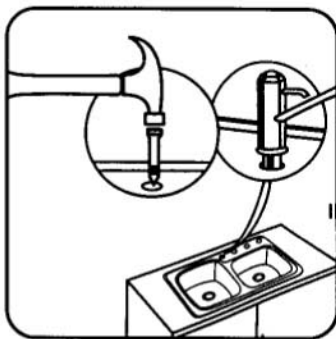
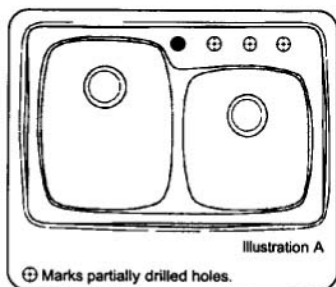

STEP FOUR

Seal Countertop

Place a thin bead of silicone sealant around the perimeter of countertop cutout. This will ensure that the sink is completely sealed to the countertop.

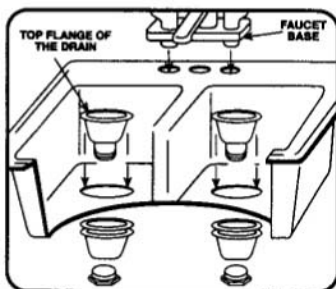

STEP FIVE

Attach Faucet and Accessories

To simplify installation, we recommend the installer attach faucets, strainers and accessories at this time.

- When fitting the drain to the sink, take extra care not to overtighten. Overtightening can add a mechanical stress in the region of the drain hole which could damage or crack the sink. We recommend the screw fitting be hand tight plus one eighth turn.

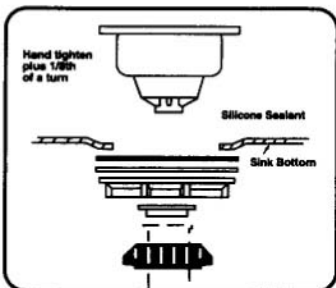

STEP SIX

Mounting Brackets

The six mounting brackets have been pre-attached to the sink for your convenience. Assemble the mounting clips and bolts as shown in the diagram. Space for ten clips have been provided. However, our tests have shown that the six clips provided are more than adequate to hold your sink in place until the sealant applied in step four is dry. If you need additional hardware, please call our customer service department at 1-800-637-6485.

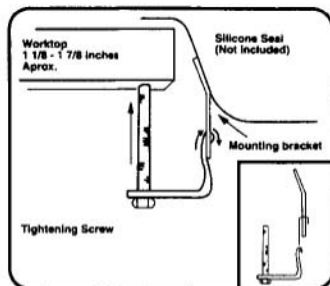

STEP SEVEN

Check the alignment of the sink and then following the clamping sequence (check figure), partially tighten each bolt in turn. Repeat sequence until bolts firmly grip countertop. It is not necessary to overtighten these bolts to seal the sink.

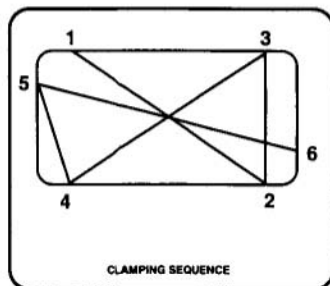

STEP EIGHT

Hook up plumbing, check for leaks.

NEW COUNTERTOP INSTALLATION ONLY

If you are installing a new countertop along with your new sink, the following instructions should be used. It will be much easier to make the cutout and install the sink before the countertop is secured to the base cabinets.

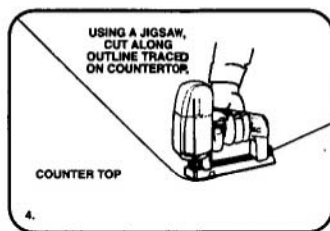
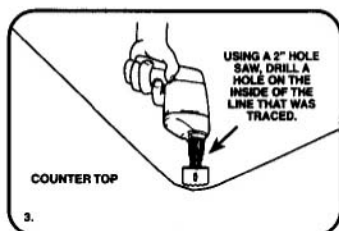
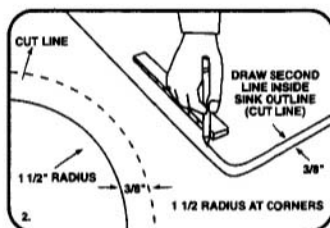
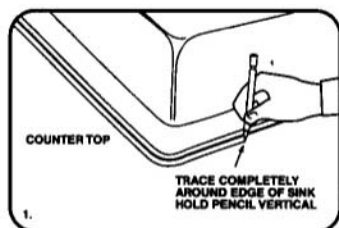

CARE AND MAINTENANCE

Your new Granite sink is an extremely tough and resilient material that will last a lifetime of normal usage. To keep its good looks and sparkling finish follow these simple guidelines.

CLEANING

- Most stains incurred during normal daily use can be washed away with water and a mild cleaner such as COMET, AJAX, BON AMI, BAR KEEPERS FRIEND, SOFT SCRUB and a green SCOTCH BRITE pad.
- Some very stubborn stains may require a dilute solution of bleach. DO NOT leave concentrated bleach soaking in your sink. (This could cause your sink to discolor).
- Aluminum kitchen utensils and pots and pans may leave a silver mark on your sink. These marks can easily be removed with an abrasive cleaner or a SCOTCH BRITE pad. Hard water deposits can be removed with an abrasive cleaner, vinegar or lemon juice.
- To prevent staining and discoloration of your sink always rinse your sink after use with clean warm water.

MAINTENANCE

- Your Granite sink is resistant to normal household detergents. However, avoid prolonged exposure to paint strippers, caustic soda, descalers and nail varnish. These items could cause your sink to discolor.
- Do not use wire wool or steel soap pads as steel particles can become embedded in your sink and rust.
- Your sink will withstand temperatures of up to 550 degrees F. Most accessories such as wire baskets will not withstand temperatures that extreme and may melt.
- Always rinse your sink with warm clean water after use. If you have hard water, you should also wipe your sink dry.

LIMITED LIFETIME WARRANTY

Products are warranted to be free from defects in materials and workmanship for the following period from the date of sale to the user.

This warranty does not cover:

1. Any obligation other than the replacement of defective parts when presented to the selling distributor, together with proof of purchase during the warranty period.
2. Any labor charges, removal and reinstallation expense, freight or postage, or any incidental or consequential damages resulting from any defective product.
3. Products classified as "accessories."

This warranty shall be voided by any of the following:

1. Modification to this product.
2. Improper installation, care or maintenance of the product.
3. Use of product for any purpose other than that for which specifically intended.

This warranty supersedes all other warranties, expressed or implied.

The foregoing warranties are exclusive and made only to the Buyer. NO OTHER WARRANTY, WHETHER EXPRESSED, IMPLIED, OR STATUTORY INCLUDING ANY WARRANTY OF MERCHANTABILITY OF FITNESS FOR A PARTICULAR PURPOSE SHALL EXIST IN CONNECTION WITH ANY OF THE GOODS OR SERVICES SUPPLIED HEREUNDER, AND ALL SUCH WARRANTIES ARE HEREBY EXPRESSLY EXCLUDED. No employee, agent or other person is authorized to give any warranties in addition to or different from those herein given to assume any other liability in connection with any of its products except in writing which is signed by an officer and expressly and intentionally gives such warranties or assumes such liability.