

ASSEMBLY INSTRUCTIONS

ADULT ASSEMBLY REQUIRED.
NO TOOLS REQUIRED.

- READ ALL INSTRUCTIONS BEFORE ASSEMBLY AND USE OF CRIB.
- Unpack carton and identify all parts.
- Ask your dealer or contact Foundations® (Monday through Friday, 9:00 a.m. to 4:00 p.m. Eastern Time) for assistance, replacement parts, or instructions if needed. Please have ready the crib model number and manufacture date printed on the top surface of mattress support.

Call or write:

Foundations®
7001 Wooster Pike
Medina, OH 44256
Telephone: 1-877-716-2757
(U.S. Only)
or 1-330-722-5033
Fax: 1-330-721-6799

!WARNING

- Before each usage or assembly, inspect crib for damaged hardware, loose joints, missing parts or sharp edges. DO NOT use crib if any parts are missing or broken. DO NOT substitute parts.
- Avoid injury from pinching, keep fingers away from hinges during assembly, set up, and folding of crib.

CASTER ASSEMBLY

1. Lay crib on its side.
NOTE: Place crib on a smooth or padded surface to prevent damage to painted surfaces.
2. Insert 2 *Locking Casters* into ends of two corner tubes on right side of crib (*Fig. D*).
3. Repeat step 1 for the 2 *Nonlocking Casters* inserting them into corner tubes in left side of crib.
4. Lift crib and stand up on casters.

Assembly is now complete.

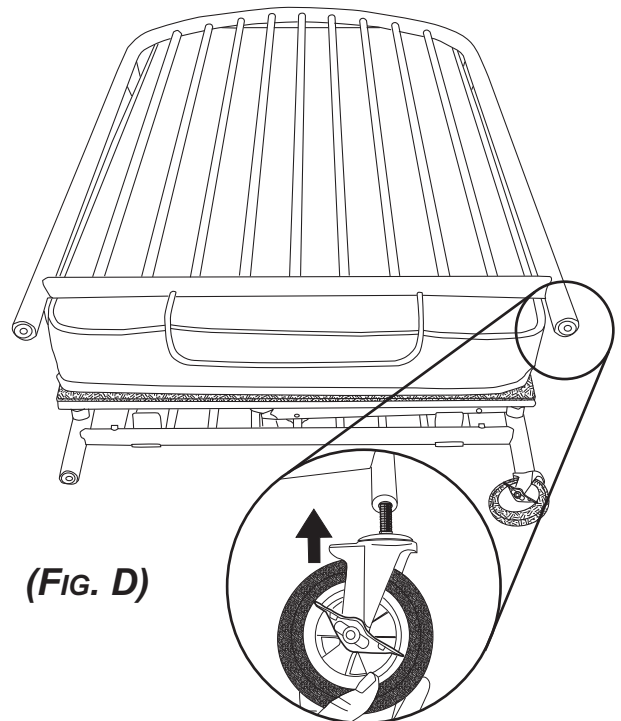

CRIB SET UP INSTRUCTIONS

⚠️ WARNING

- Avoid injury from pinching, keep fingers away from hinges during assembly, set up, and folding of crib.

1. Remove *Mattress* and set aside (*Fig. A*).
2. Undo closure strap (*Fig. A*).
3. While holding *Mattress Support* up, unfold Crib until sides are fully extended (*Fig. B*).
4. Carefully lower *Mattress Support* and push down on *Mattress Support* to lock *Mattress Support Latch "A"*.
5. Lock both *Red Mattress Support Latches "B"* (*Fig. C*).
6. Pull up on end of *Mattress Support* to check that *Mattress Support* is locked in position.
7. Insert *Mattress* in crib (*Fig. D*).

This completes the crib set up.

Verify proper set up and operation.

Crib is ready for use.

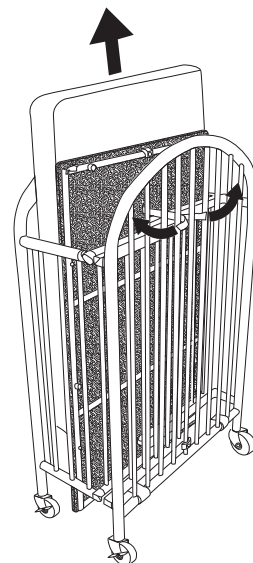

(FIG. A)

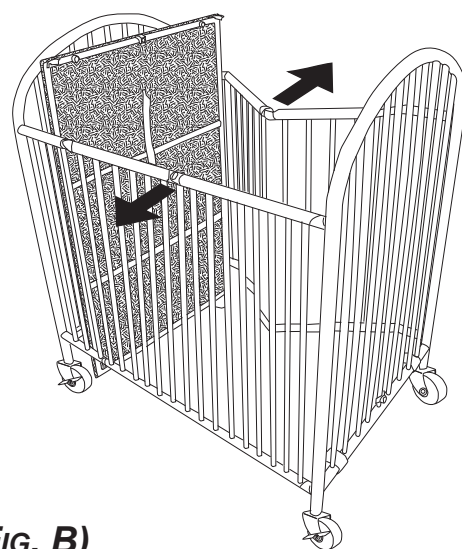

(FIG. B)

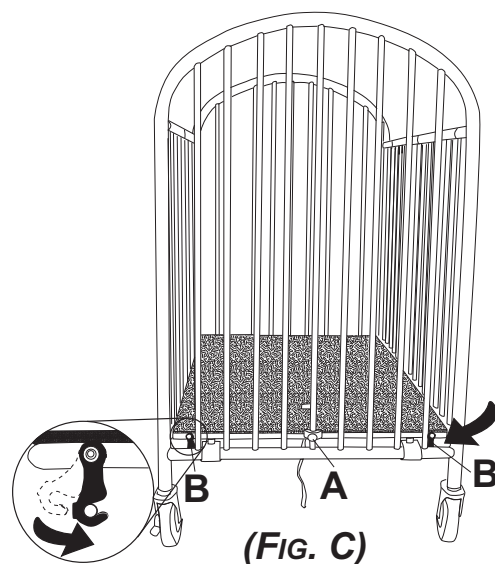

(FIG. C)



(FIG. D)

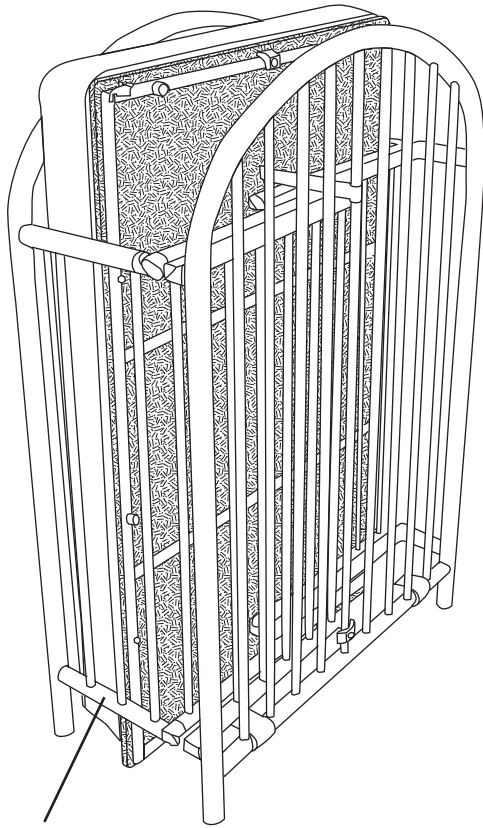

Crib Assembly
Assemblage de lit d'enfant
Ensamblaje de la cuna

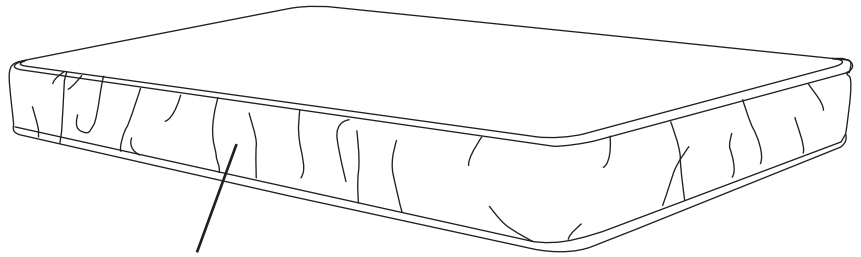

Mattress
Matelas
Colchón

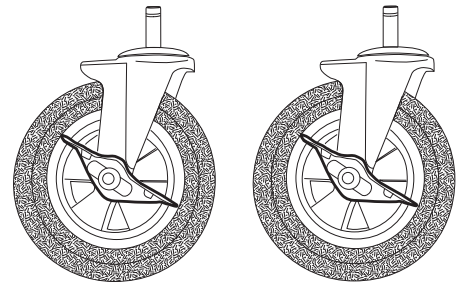

Locking Casters
Roulettes à blocage
Ruedas de inmovilización

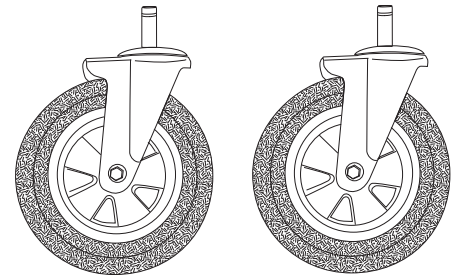

Nonlocking Casters
Roulettes non blocables
Ruedas libres

PARTS LIST / LISTE DES PIÈCES / LISTA DE PIEZAS

Part Description / Désignation de la pièce / Descripción de piezas	Qty. / Cantidad
Crib Assembly / Assemblage de lit d'enfant / Ensamblaje de la cuna	1
Mattress / Matelas / Colchón	1
Locking casters / Roulettes à blocage / Ruedas de inmovilización	2
Nonlocking casters / Roulettes non blocables / Ruedas libres	2

ONE YEAR LIMITED WARRANTY

Foundations® warrants this product to be free from all defects in material and workmanship when used according to the manufacturer's instructions to the original owner for a period of one year from date of purchase. The warranty does not apply to damage caused by product alteration, normal wear and tear, misuse or abuse of the product. Keep your sales receipt as a record of the date of purchase. For replacement parts or warranty issues, please contact Foundations® as we are better able to serve you. **DO NOT** return the product to your retailer or distributor.

If you need assistance, call or write:

Foundations®
7001 Wooster Pike
Medina, OH 44256
Telephone: 1-877-716-2757
(U.S. Only)
or 1-330-722-5033
Fax: 1-330-721-6799



Foundations®

Division of Shamrock Industries, Inc.

**7001 Wooster Pike
Medina, OH 44256
Telephone: 1-877-716-2757 (U.S. Only)
or 1-330-722-5033
Fax: 1-330-721-6799**