

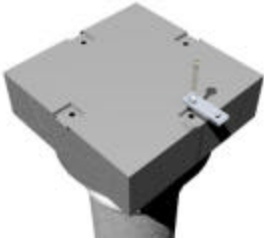

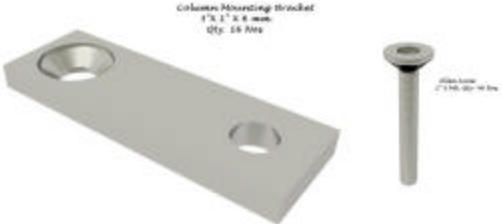

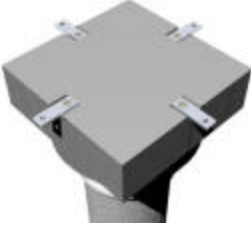

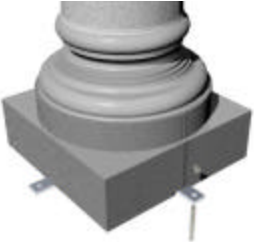



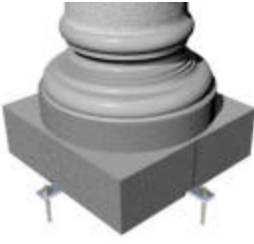

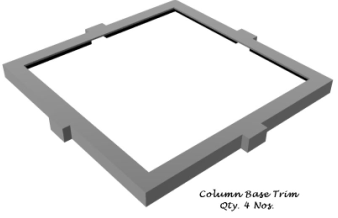
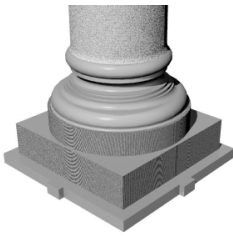

# Pergola Installation Manual





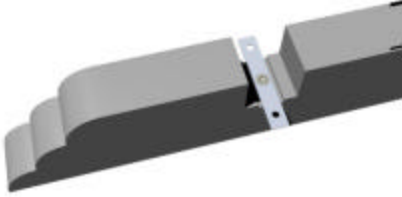

Thank you for selecting our Pergola. This fine product has been carefully manufactured and will provide you with many years of carefree service. Please follow these instructions in the steps shown. Most importantly, **DO NOT** fully tighten any bolts or screws.

Step	Description	Installation	Part Name
1	Fix 4 nos. of column mounting Stainless Steel base brackets with allen screws as shown in the picture.		
		Fixing of base bracket	Base Bracket / Allen Screw
2	Now all 4 nos. of base brackets are in place.		
		All 4 Base bracket are place	

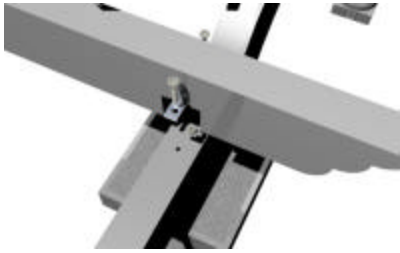
<p><b>3</b></p>	<p>Place columns on desired location, anchor it to the ground or foundation with the help of an anchor bolt.</p>			
		<p>Fixing of coloumn with Anchor bolt</p>	<p>Anchor Bolt</p>	
<p><b>4</b></p>	<p>4 nos. anchor bolts are provided with the kit.</p>			
		<p>All 4 colomun are fixed with anchor bolt</p>		
<p><b>5</b></p>	<p>Insert base trim over the coloumn to hide the anchor bolts. This protects your toes while walking bear footed near the Pergola.</p>			
		<p>Insert Column Base Trim</p>	<p>Column Base Trim</p>	
<p><b>6</b></p>	<p>Glue the base trim with the help of silicon glue.</p>			
		<p>Base Trim is installed</p>		

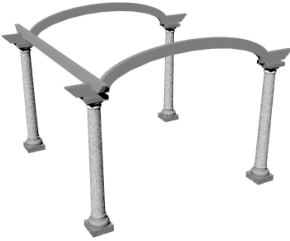
<b>7</b>	Install all 4 coloumns		
		4 Columns are installed	Column

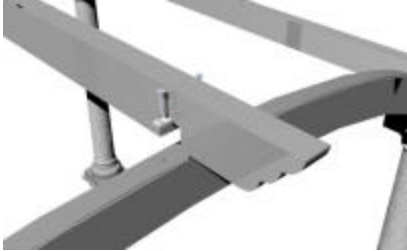
8	Install main curved rafter with the help of long allen bolts provided with the kit.		
		Insert Allen Bolt	Allen Bolt
9	Install other side of the rafter, same as above.		
		Curved Rafter Installed	Second curved Rafter is Installed
10	Fix metal bracket to the rafter with the help of allen screws. Prepare all 5 rafters in similar manner.		
		Fixing of Metal Bracket	Metal Bracket
11	Rafters are ready for assembly.		
		Metal Bracket is fixed on to the rafter	

<p><b>12</b></p>	<p>Fix rafter on to the main curved rafter.</p>		
		<p>Fixing of rafter</p>	
<p><b>13</b></p>	<p>Fix second rafter on to the main curved rafters.</p>		
		<p>First rafter installed</p>	<p>Second rafter installed</p>
<p><b>13</b></p>	<p>Fix third, fourth and fifth rafter on to the main curved rafters.</p>		
		<p>Third, Fourth and Fifth rafter installed</p>	
<p><b>14</b></p>	<p>Your Pergola is ready to use.</p>		
		<p>Ready Pergola</p>	