







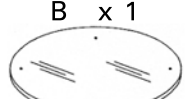

Assembly Instructions

Veronica Cart

PLEASE NOTE: Check that you have received all components and hardware before assembling. If you are missing any parts, contact your retailer, or fax Euro Style at 415-455-8033.

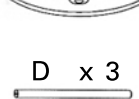
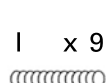
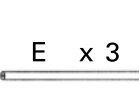

- | | |
|---|---|
|  A x 1 |  F x 2, x 2 |
|  B x 1 |  G x 3 |
|  C x 1 |  H x 9 |
|  D x 3 |  I x 9 |
|  E x 3 | Tools |
| |  |

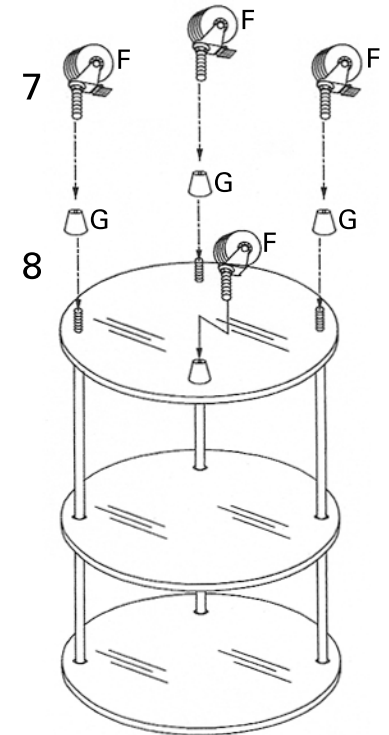
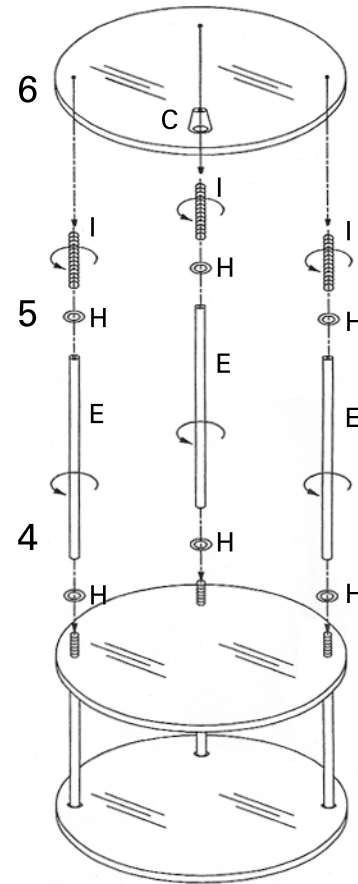
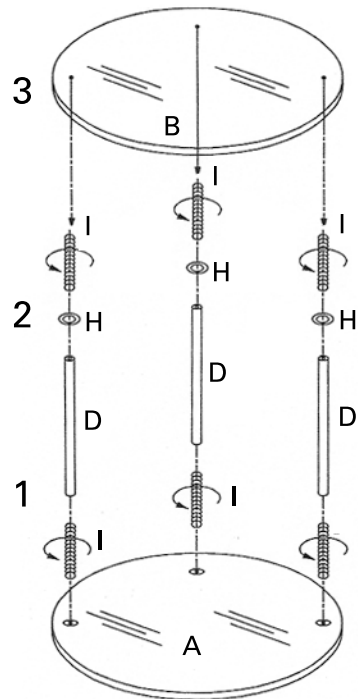

During assembly, **hand tighten** screws only. When all screws are in place, then tighten completely.