

W
WESTWOOD DESIGN



Assembly Instructions
Spring Creek Dressing Combo



WARNING: FALL HAZARD

- TO PREVENT DEATH OR SERIOUS INJURY, ALWAYS KEEP CHILD WITHIN ARM'S REACH.
- THIS PRODUCT NOT TO BE USED AS A CHANGING TABLE UNLESS EQUIPPED WITH CHANGING PAD AS DESCRIBED BELOW.
- READ ALL INSTRUCTIONS BEFORE USE OF THE CHANGING TABLE OR THE CHANGING PAD.
- DO NOT USE CHANGING TABLE OR CHANGING PAD IF BROKEN.
- KEEP ALL INSTRUCTIONS FOR THE FUTURE.
- USE ONLY AN APPROVED CHANGING PAD THAT MEETS F23388-04. THE PAD WILL HAVE A LABEL THAT INDICATES IT MEETS F23388-04 AND MAY BE SOLD BY ANOTHER MANUFACTURER. FOLLOW ALL PAD MANUFACTURER'S INSTRUCTIONS.

Congratulations on your purchase of a Westwood product. We take great pride in the quality and design of our furniture. The safety of your child is our highest priority. It is important that you read these instructions carefully and completely to ensure that this product functions as it was designed.

After opening the package, check to see that all the parts are present. If you think something is missing, please contact your retailer, and they can arrange to have the missing parts quickly replaced. You can also contact Westwood directly, by calling 1-908-719-4707, or emailing support@westwoodbaby.com.

If any aspect of these instructions is unclear, please contact your retailer or Westwood for assistance.

Parts Included in Package:

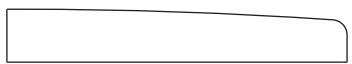
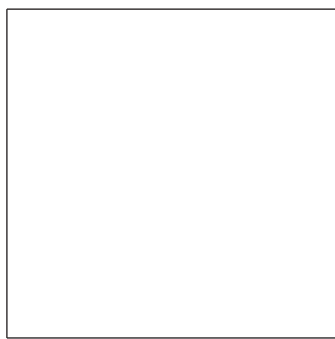
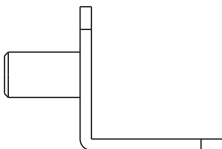
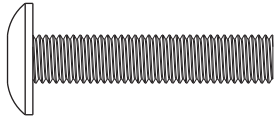
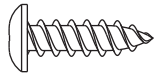
A Galley Rail Back 	B 2 x Galley Rail Side 
C Shelf 	D 4 x Shelf Tab 
E 4 x Phillips Head Bolt 	F 2 x Wood Screw 

Step 1

- A.** Align the holes in the galley rail sides (B) with the holes in the galley rail back (A).
- B.** Thread the bolt (E) through the hole. Tighten securely using a phillips head screwdriver. Repeat for the other hole.
- C.** Repeat for the other side.

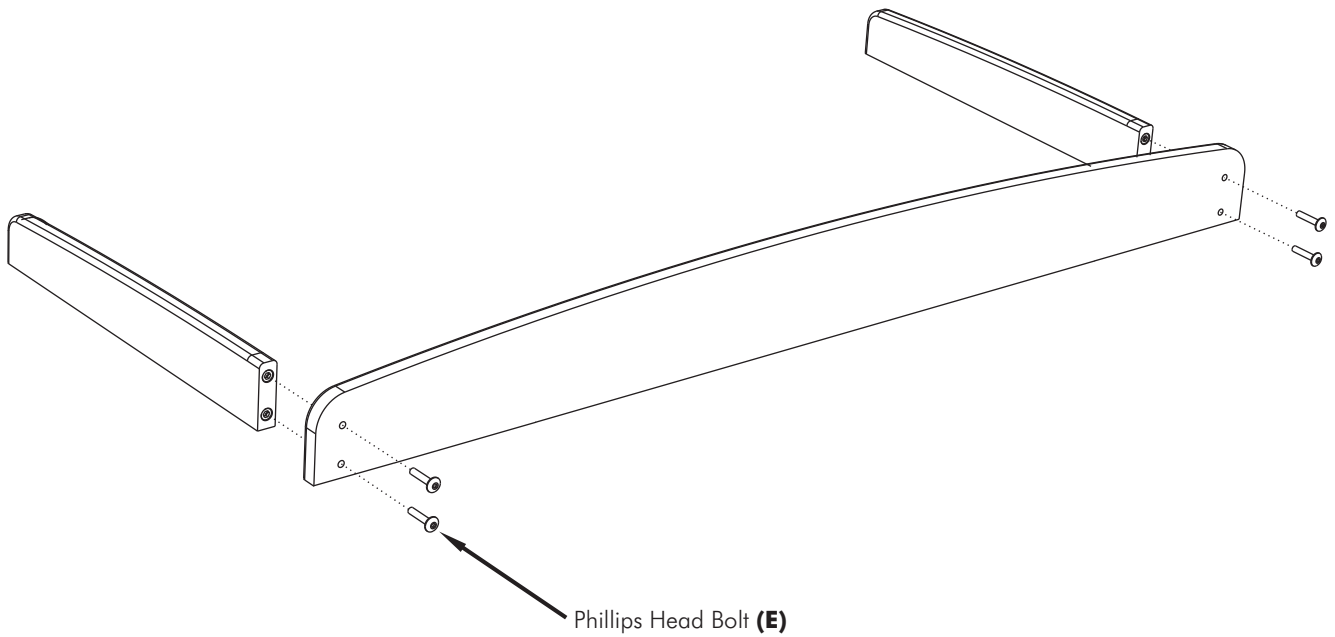

Step 2

- A.** If you are using a changing pad, secure it to the combo using the straps as instructed by the pad manufacturer.
- B.** Rotate the mounting plates on the combo so they sit vertically.
- C.** Center the galley rail on the top, then screw the wood screws (F) through the holes on the mounting plates and into the back of the galley rail.

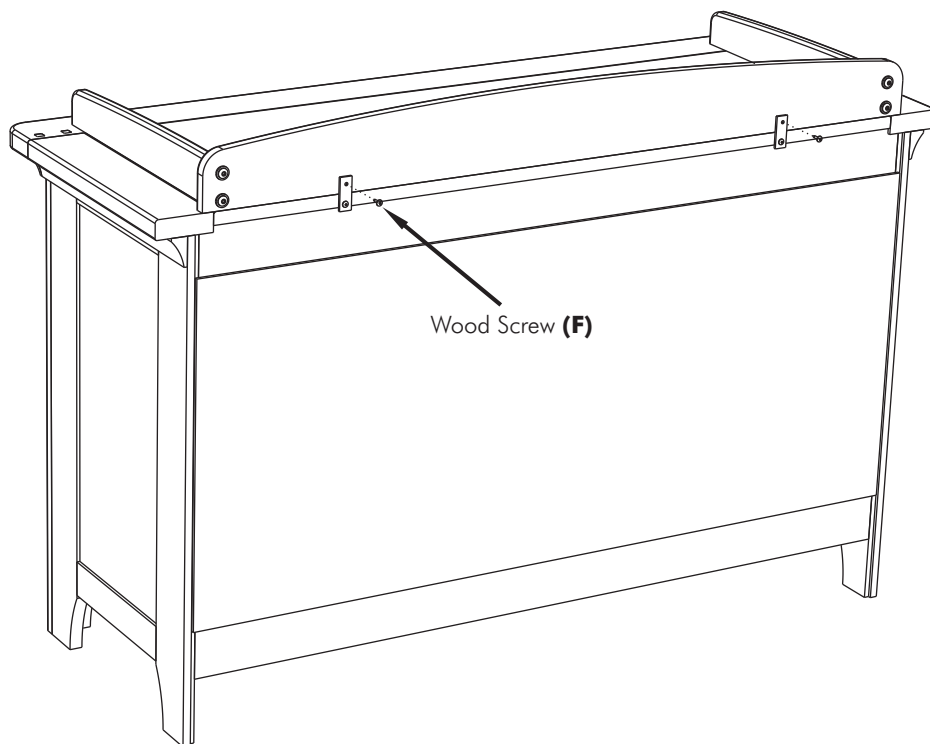

Step 3

A. Insert the shelf tabs (D) into the holes on the inside of the door, and carefully lower the shelf (C) onto the tabs.

B. If desired, you can screw $\frac{1}{2}$ " long wood screws (not included) through the holes in the bottom of the shelf tabs into the bottom of the shelf to prevent the shelf from being accidentally removed.

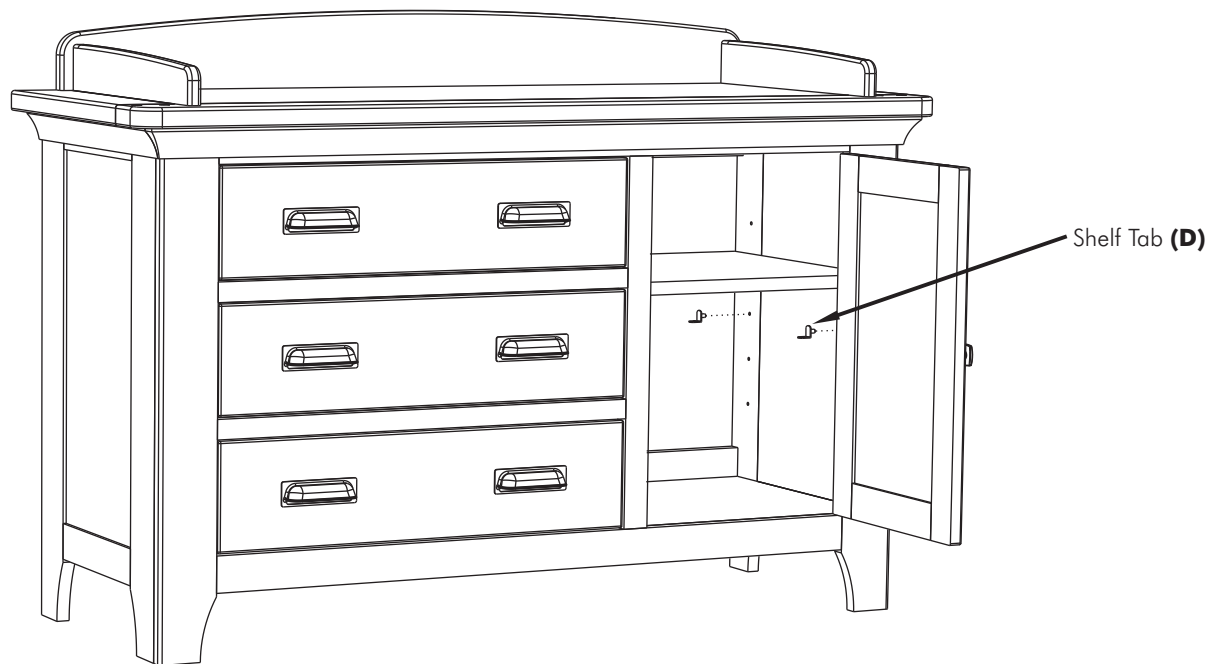

W
WESTWOOD DESIGN

635 N. Billy Mitchell Rd., Ste. B
Salt Lake City, UT 84116
Phone: 1-908-719-4707
support@westwoodbaby.com

June 7, 2006