

INSTALLATION EXAMPLE

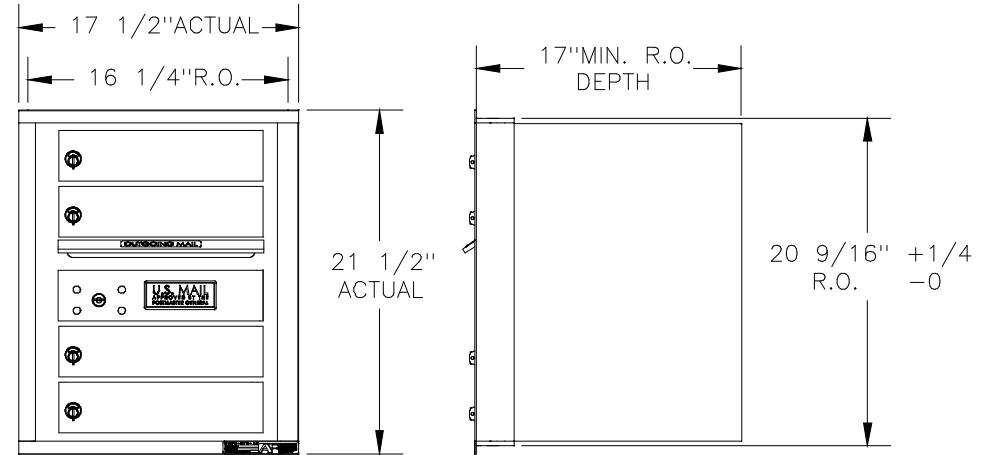
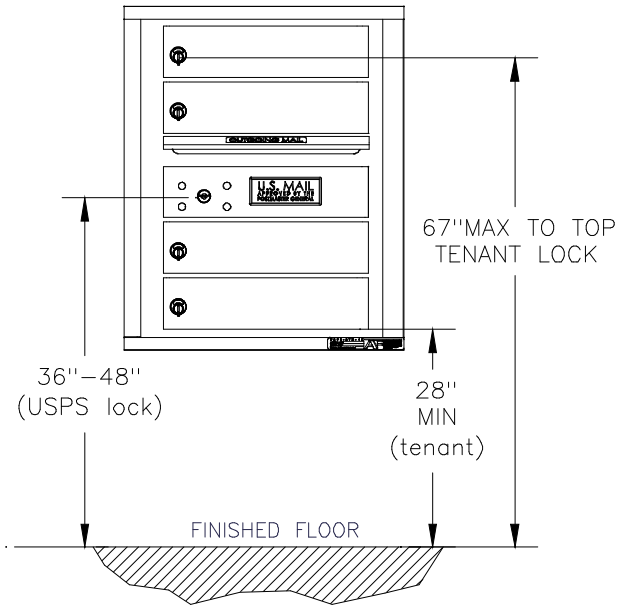

Installation requirements specified in USPS STD-4C include:

1. At least one customer compartment shall be positioned less than 48" from the finished floor.
2. No parcel locker (interior bottom shelf) shall be positioned less than 15" from finished floor.
3. No patron (tenant) lock shall be positioned more than 67" above finished floor.
4. No customer compartment (interior bottom shelf) shall be positioned less than 28" from finished floor.
5. The USPS Arrow lock shall be positioned 36"- 48" above finished floor.

AUTH AF FLORENCE
 MANUFACTURING COMPANY
 5935 CORPORATE DRIVE
 MANHATTAN KANSAS 66503

PRODUCT SERIES		
4C HORIZONTAL - SUITE D		
MODEL		
4CDT6-4		
DRAWING NUMBER	DRAWN BY	DATE
CS4CDT64	R.T.	6/12/06