

# H08807-Cottage Corner Desk

## Assembly Instructions



For assistance with assembly contact:  
Southern Enterprises, Inc.  
Customer Service 1-800-633-5096

[om](http://www.seidal.com)

[www.seidal.com](http://www.seidal.com)

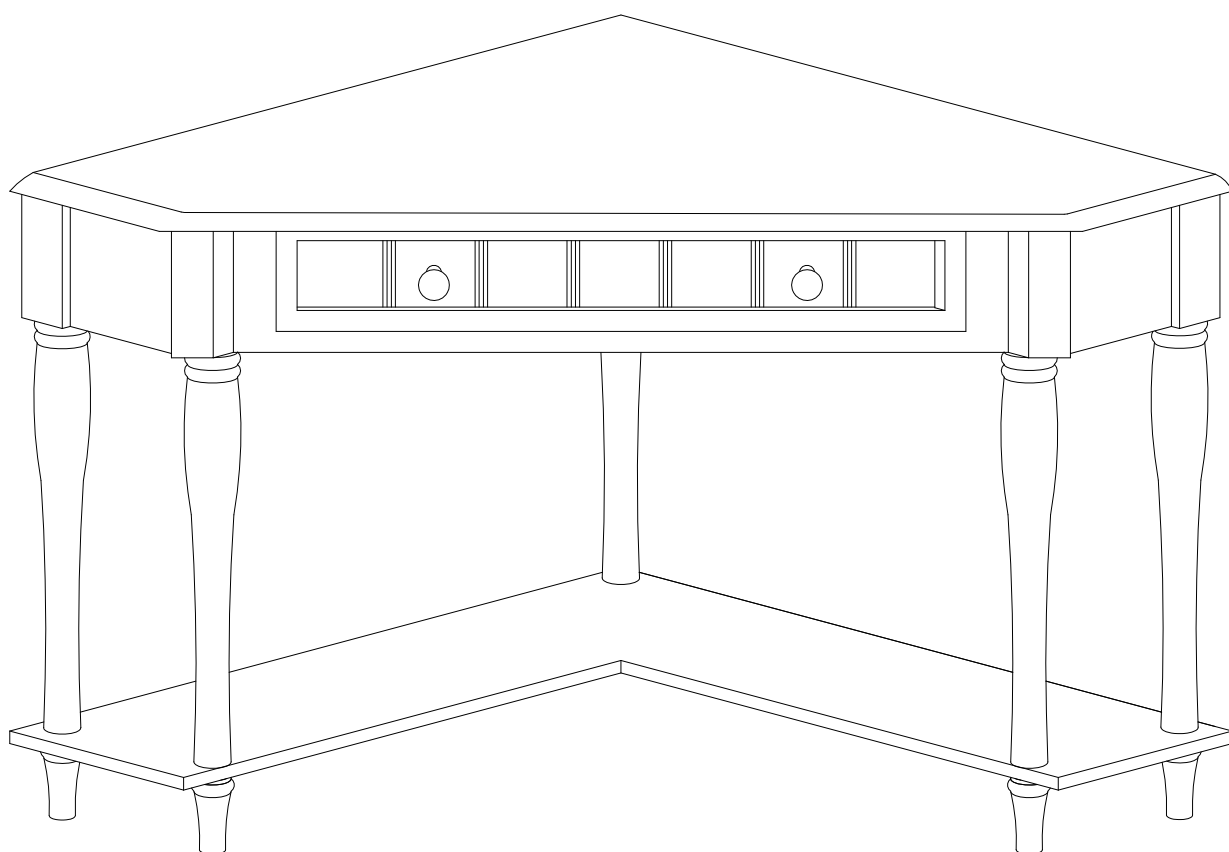

# Parts List

Please review all parts and hardware before disposing of any packaging.  
 Call Customer Service if missing hardware. Do not return to store/retailer.  
 Screws shown in actual size. Using a screw that is too long will cause damage.  
 Before beginning assembly, separate each type of screw. Carefully study  
 the screw diagrams below (SHOWN ACTUAL SIZE). You may receive extra  
 hardware with your unit.

**A** Quantity  
of 1

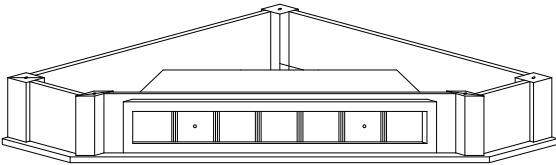

Desk Top

**B** Quantity  
of 5

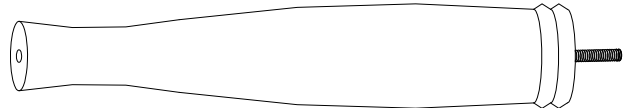

Upper leg

**C** Quantity  
of 5

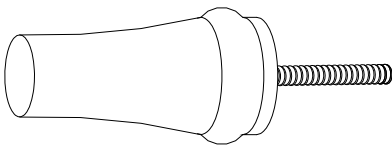

Lower leg

**D** Quantity  
of 1

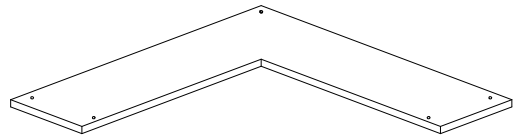

Bottom Shelf

**1** Quantity  
of 4

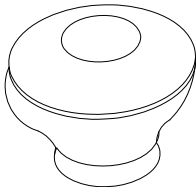

Knob

**2** Quantity  
of 4

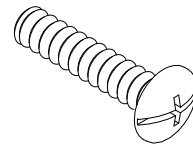

Bolt(5/32"\*1")

Care and Cleaning Instructions:  
 Before using, wipe with a clean, dry cloth.  
 Periodically apply furniture wax to renew  
 the finish. Avoid rubbing or scratching the  
 surface with rough or abrasive objects.

For replacement parts or questions, please  
 Call Customer Service at 1-800-633-5096  
 Do not return product to store, please call  
 Manufacturer for assistance, questions or  
 Parts.

**Assembly Tool Required**  
**No.2 Phillips Screwdriver**

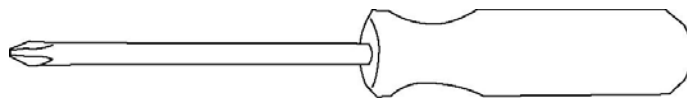

# Cottage Corner Desk Assembly Instructions

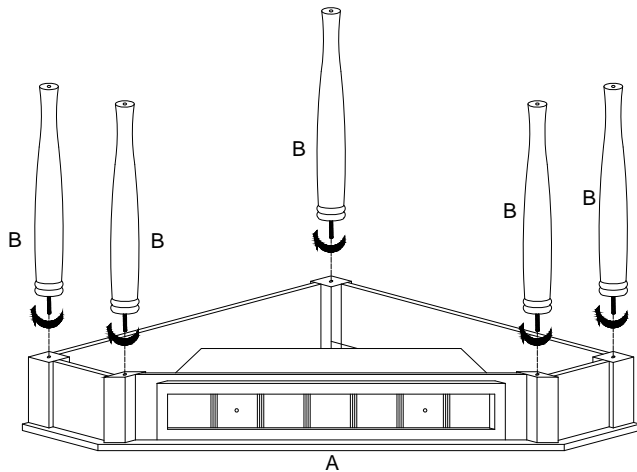

Figure 1

## Assembly Instructions:

Wood may scratch easily, Be careful when assembling. Do not scratch.

Step 1 Unpack and lay parts on clean, padded surface like carpet or blanket. Check that you have all parts indicated on the front page.

Step 2 Set the desktop upside down on smooth padded surface.

Step 3 Attach the 4pcs Upper Leg (B) to the Desk Top (A) by screwing each leg in its respective hole as figure shown.

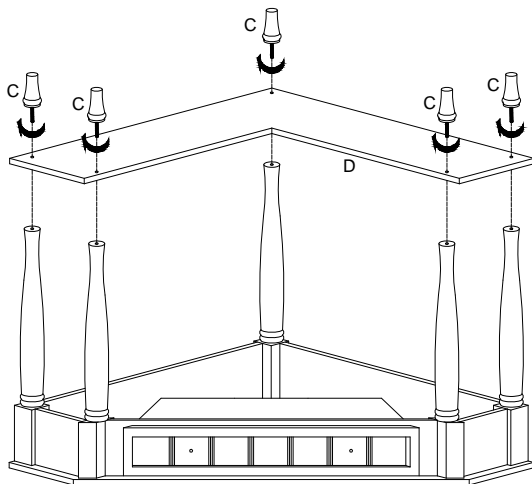

Figure 2

Put the Bottom Panel (D) and the 5pcs lower legs (C) onto the Upper Legs (B), then rotate the Lower Legs (C) till they are firmly attached.

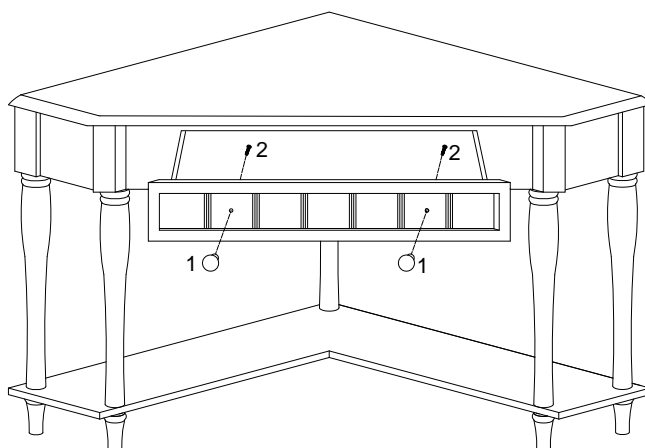

Figure 3

Fix the 2pcs Knob (1) with 2 pcs Small Bolt (2) as figure shown.



Customer Service 1-800-633-5096

Southern Enterprises, Inc.  
2915 Merrell Road  
Dallas, Texas 75229

## H08807 - Parts Replacement Form

### Customer Information

Name \_\_\_\_\_

Address \_\_\_\_\_

City/State/Zip Code \_\_\_\_\_

Phone Number \_\_\_\_\_

Please indicate where you purchased this item: Store/Website/Catalog

\_\_\_\_\_

Please indicate color/size/style number:

\_\_\_\_\_

Style No	Parts Letter	Parts Description	Quantity Needed
----------	--------------	-------------------	-----------------

\_\_\_\_\_

\_\_\_\_\_

\_\_\_\_\_

Missing or damaged hardware and/or parts will be replaced free of charge. We do not sell parts. Southern Enterprises Inc. will provide replacement parts for only those items purchased within the last 9 months. If this product has not been purchased from our retail affiliates (within 9 months), we are under no obligation to provide parts or replacement merchandise. Parts will not be available for items arriving fully assembled.