









JCP LOT# 778-9037  
 STYLE NO. CM8980

**SOUTHERN ENTERPRISES INC.**  
 RELAX...If you can follow a few easy, step-by-step directions  
 in order .YOU CAN ASSEMBLE THIS ITEM.

**4PC GOLD CONSOLE SET**

**PLEASE FIND HARDWARE IN RED POLYBAG BEFORE DISCARDING PACKING MATERIAL.**

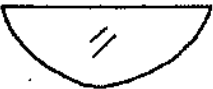
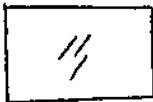
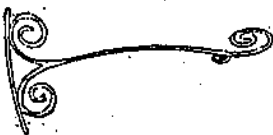
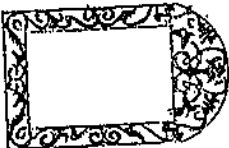
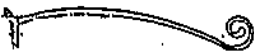
HARDWARE LIST			
(1) LONG MACHINE SCREWS	3PCS	(2) WOOD SCREWS	6PCS
			
(3) SHORT MACHINE SCREWS	6PCS	(4) PLASTIC ANCHORS	6PCS
			

PARTS LIST			
(A) IRON TOP FRAME	1PCS	(F) IRON CONNECTOR	1PC
			
(B) GLASS TOP	1PC	(G) MIRROR	1PC
			
(C) IRON FRONT FRAME	1PC	(H) IRON MIRROR FRAME	1PC
			
(D) IRON LEFT SIDE FRAME	1PC	(I) SCONCE	2PCS
			
(E) IRON RIGHT SIDE FRAME	1PC		
			

### ASSEMBLY INSTRUCTION

1. SELECT A SMOOTH, SOFT SURFACE TO PREVENT SCRATCHING FINISH.
2. YOU MAY NEED A PHILLIP SCREWDRIVER.
3. INSERT LONG MACHINE SCREWS (1) THROUGH PREDRILLED HOLES ON IRON CONNECTOR (F) AND TIGHTEN INTO THREADED HOLES ON IRON FRONT FRAME (C), IRON LEFT AND RIGHT SIDE FRAME (D, E). INSERT SHORT MACHINE SCREWS (2) THROUGH PREDRILLED HOLES ON IRON FRONT FRAME (C), IRON LEFT AND RIGHT SIDE FRAME (D, E) AND TIGHTEN INTO THREADED HOLES ON IRON TOP FRAME (A). AS FIGURE 1 SHOWN.

FIGURE 1

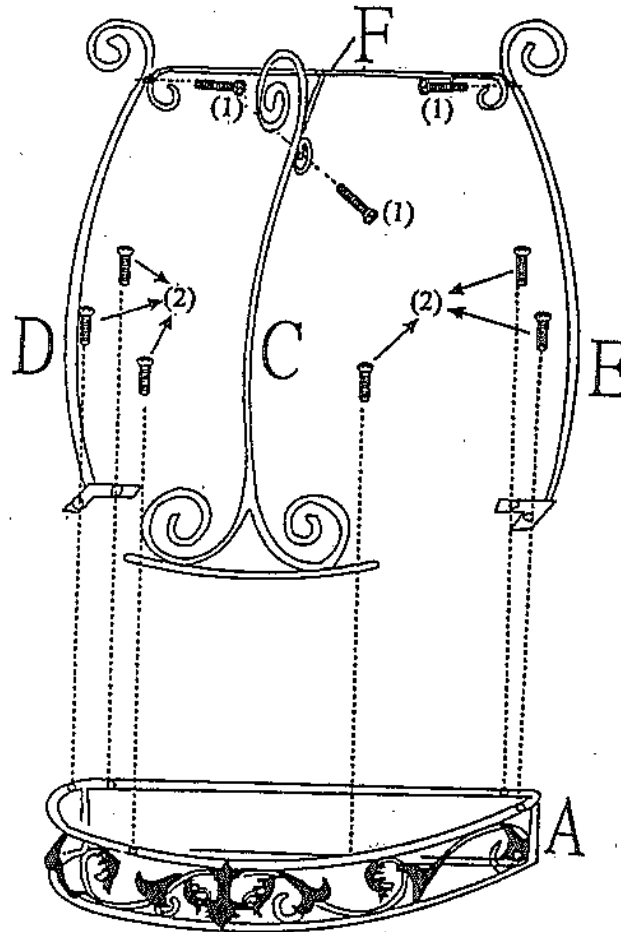

4. IN ORDER TO STAND STURDILY, DRILL TWO 1/4" DIAMETER HOLES ON WALL, THE DISTANCE BETWEEN TWO HOLES SHOULD MATCH TO THE HANGING HOLES ON BACK OF IRON TOP FRAME (A). FIT PLASTIC ANCHORS (4) INTO THE HOLES ON WALL, INSERT WOOD SCREWS (3) THROUGH HANGING HOLES ON BACK OF IRON TOP FRAME (A) AND TIGHTEN INTO PLASTIC ANCHORS (4). THEN PLACE GLASS TOP (B) ON UPSIDE OF IRON TOP FRAME (A). AS FIGURE 2 SHOWN.
5. INSERT MIRROR (G) INTO SLOTS OF IRON MIRROR FRAME (H). DRILL TWO 1/4" DIAMETER HOLES ON WALL, THE DISTANCE BETWEEN TWO HOLES SHOULD MATCH TO THE HANGING HOLES ON BACK OF IRON MIRROR FRAME (H). FIT PLASTIC ANCHORS (4) INTO THE HOLES ON WALL, TIGHTEN WOOD SCREWS (3) INTO PLASTIC ANCHORS (4). THEN PUT THE ASSEMBLED MIRROR MOUNTED ON WALL WITH HANGING HOLES TO WOOD SCREWS (3). AS FIGURE 2 SHOWN.
6. DRILL TWO 1/4" DIAMETER HOLES ON WALL NEAR SIDES OF MIRROR, FIT PLASTIC ANCHORS (4) INTO THE HOLES ON WALL, TIGHTEN WOOD SCREWS (3) INTO PLASTIC ANCHORS (4). THEN PUT THE SCONCES ON WOOD SCREWS (3). AS FIGURE 2 SHOWN.

**FIGURE 2**

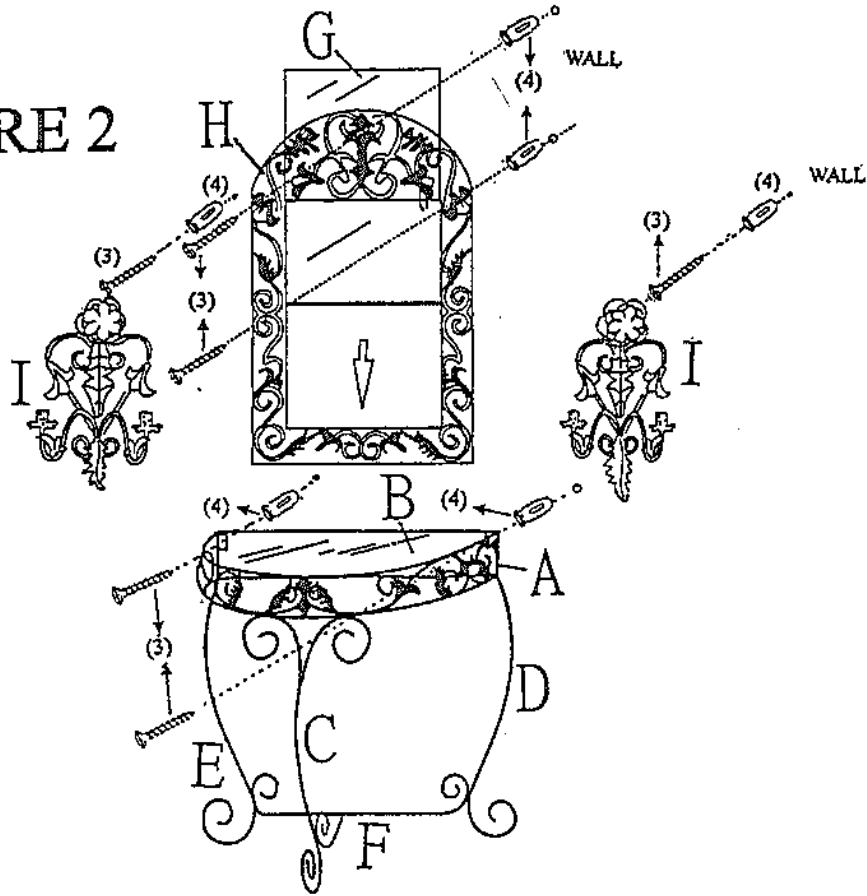

**YOUR NEW 4PC GOLD CONSOLE SET IS FINISHED AND READY TO USE.**

Please count, identify and compare parts and hardware list to be sure all parts are present. Extra hardware may be included. If any items are missing, please contact our parts/ service department at (800) 633-5096 or in Dallas (972) 869-0111/ 9am-4pm Mon-Fri central time. Missing or damaged hardware and/ or parts will be replaced free of charge. **WE DO NOT SELL PARTS.**

**WE DO NOT RECOMMEND MODIFYING PRODUCT(S) AND WE ARE NOT RESPONSIBLE FOR ANY DAMAGES DUE TO PRODUCT MODIFICATION(S).**

**PARTS REPLACEMENT FORM**

JCP LOT# 778-9037  
 STYLE NO: CM8980

Customer Name \_\_\_\_\_

PARTS  
 LETTER

PART  
 DESCRIPTION

QUANTITY  
 NEEDED

Street, City, State, Zip \_\_\_\_\_

Phone# \_\_\_\_\_



Please indicate where you purchased this item.  
 Store/website/catalog \_\_\_\_\_

Please indicate color/size/style number \_\_\_\_\_

SOUTHERN ENTERPRISES INC.  
 P.O. Box 59996 Dallas, Texas 75229