

Style No.BE821200TX WALL MOUNT SWIVEL MIRROR SHELF

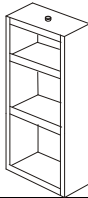

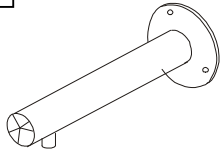

RELAX...if you can follow a few easy,step-by step directions in order, YOU CAN ASSEMBLE THIS ITEM.

PARTS LIST

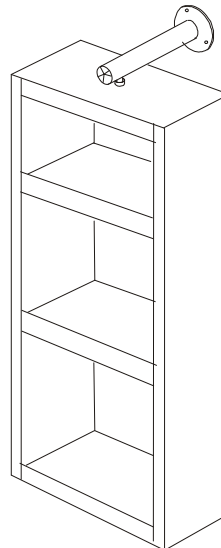
1		2	
	UNIT FRAME 1 PC		SUPPORTS 2 PCS

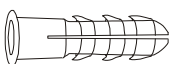
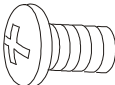

HARDWARE LIST

A		B		C		D	
	SCREW 6 PCS		PLASTIC WALL ANCHOR 6 PCS		SCREW 2 PCS		PLASTIC WASHER 2 PCS

Please count, identify and compare parts and hardware list to be sure all parts are present. It may help to divide parts and label them to correspond with part list. Extra hardware may be included. If many items are missing, please contact our parts/service department at(800) 633-5096 or in Dallas (972) 869-0111/9am - 4pm Mon-Fri Central time. Missing or damaged hardware and / or parts will be replaced free of charge. WE DO NOT SELL PARTS. WE DO NOT RECOMMEND MODIFYING PRODUCT(S) AND WE ARE NOT RESPONSIBLE FOR ANY DAMAGES DUE TO PRODUCT MODIFICATION(S). If this product has not been purchased from our retail affiliates (within 9 months), we are under no obligation to provide parts or replacement merchandise. Parts will not be available for items arriving fully assembled.

“We will ship parts if available” “This is not a warranty”

PARTS REPLACEMENT FORM

STYLE NO:BE821200TX

Customer Name _____

PARTS
LETTER

PARTS
DESCRIPTION

QUANTITY
NEEDED

Stree, City, State, Zip _____

Phone# _____



SOUTHERN ENTERPRISES INC..
P.O. Box 59996 Dallas, Texas 75229

Please indicate where you purchased this item.
Store/website/catalog

Please indicate color/ size/ style number.

***Suggested tools: Flat head screw driver, power drill, 1/4" drill bit, level, and a tape measure**

1/ Drill holes on the wall as below shown.

2/ Attach (2) supports to (1) unit frame by using screw (C) & plastic washer (D) as shown.

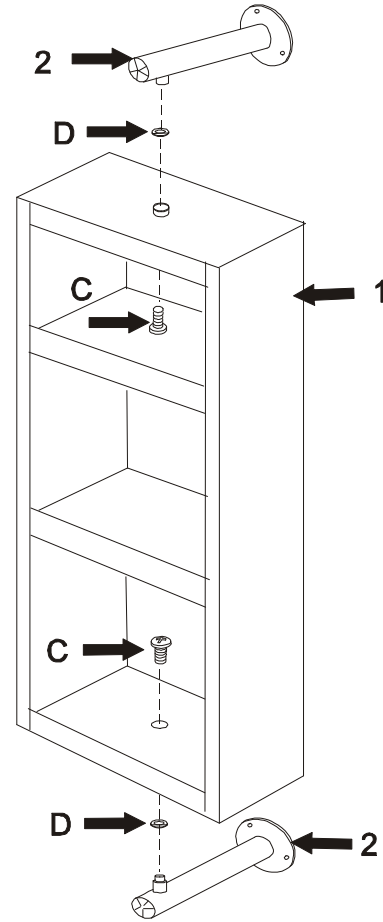
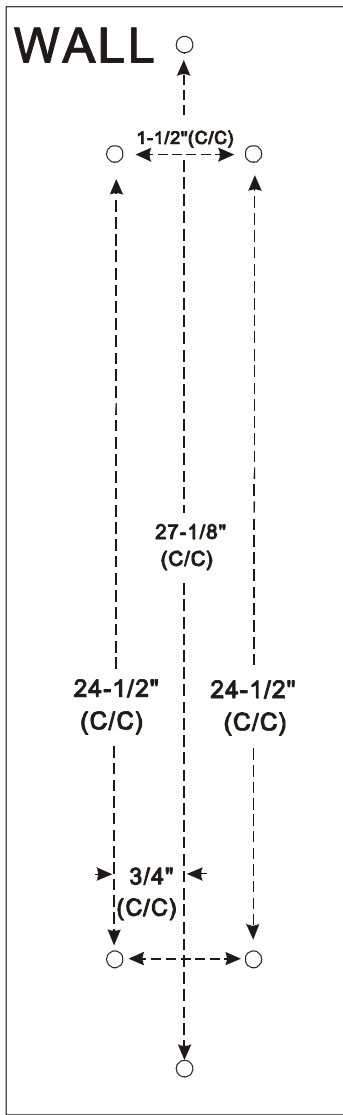

3./ Insert plastic wall anchors (B) into the holes of wall as shown. (When doing this, you will need a hammer help you).

Install the unit onto the wall by using screw (A) as shown.

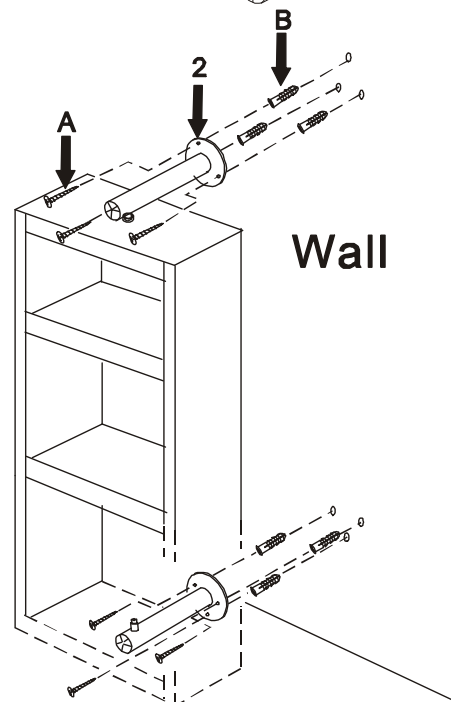

YOUR NEW WALL MOUNT SWIVEL MIRROR SHELF IS FINISHED AND READY TO USE.

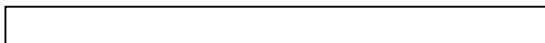

SOUTHERN ENTERPRISES, INC

P.O. Box 59996 Dallas, Texas 75229