













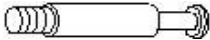
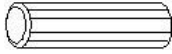

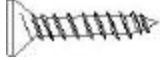

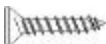
SOUTHERN ENTERPRISES INC.



RELAX...If you can follow a few easy, step-by-step directions in order . YOU CAN ASSEMBLE THIS ITEM.





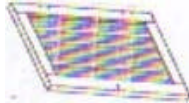

WHITE STYLE NO: BE7182
NATURAL STYLE NO: BE7582

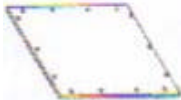
NASSAU WALL TOWEL CABINET

PLEASE FIND HARDWARE IN RED POLYBAG BEFORE DISCARDING PACKING MATERIAL.

HARDWARE LIST			
(1). METAL KNOBS	2PCS	(9). CAM-BOLTS	4PCS
			
(2). WOOD DOWELS	18PCS	(10). CAM-LOCKS	4PCS
			
(3). LARGE FLAT HEAD WOOD SCREWS	2PCS	(11). LARGE COVERS	4PCS
			
(4). SMALL FLAT HEAD WOOD SCREWS	8PCS	(12). T-BOLTS	2PCS
			
(5). PAN HEAD WOOD SCREWS	16PCS	(13). LONG MACHINE SCREWS	2PCS
			
(6). MAGNET	1PC	(14). LOCK WASHERS	2PCS
			
(7). PLASTIC ANCHORS	2PCS	(15). SMALL COVERS	2PCS
			
(8). SHELF SUPPORTS	4PCS	(16). SHORT MACHINE SCREWS	2PCS
			

PARTS LIST			
A. TOP	1PC	G. RIGHT DOOR	1PC
			
B. FIXED SHELF	1PC	H. BACK PANEL	1PC
			

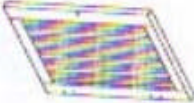
C. ADJUSTABLE SHELF 	1PC	I. UPPER CROSS BRACE 	1PC
D. LEFT SIDE PANEL 	1PC	J. LOWER CROSS BRACE 	1PC
E. RIGHT SIDE PANEL 	1PC	K. TOWEL BAR 	1PC
F. LEFT DOOR 	1PC		

ASSEMBLY INSTRUCTION

1. SELECT A SMOOTH; SOFT SURFACE TO PREVENT SCRATCHING PARTS FINISH.
2. YOU MAY NEED A PHILLIP SCREWDRIVER.
3. INSERT WOOD DOWELS (2), CAM-BOLTS (9) INTO PREDRILLED HOLES ON INSIDE OF LEFT SIDE PANEL (D). INSERT WOOD DOWELS (2), CAM-BOLTS (9) EXTENDING FROM LEFT SIDE PANEL (D) INTO CORRESPONDING HOLES ON ENDS OF UPPER CROSS BRACE (I), LOWER CROSS BRACE (J) AND FIXED SHELF (B). **PLEASE BE SURE THAT THE NOTCH ON LOWER CROSS BRACE (J) MUST BE FACING BACKWARD AND UPWARD TO FACE BACK PANEL (H).** INSERT CAM-LOCKS (10) INTO LARGE HOLES ON UNDERSIDE OF FIXED SHELF (B) WITH SLOT FOR SCREWDRIVER FACING OUTWARD. ROTATE CAM-LOCKS (10) CLOCKWISE TO SECURE CAM-BOLTS (9). PUSH LARGE COVERS (11) INTO CAM-LOCKS (10). FIT TOWEL BAR (K) INTO LARGE HOLE ON LEFT SIDE PANEL (D). INSERT WOOD DOWELS (2), CAM-BOLTS (9) INTO PREDRILLED HOLES ON INSIDE OF RIGHT SIDE PANEL (E). INSERT WOOD DOWELS (2), CAM-BOLTS (9) EXTENDING FROM RIGHT SIDE PANEL (E) INTO CORRESPONDING HOLES ON ENDS OF UPPER CROSS BRACE (I), LOWER CROSS BRACE (J), FIXED SHELF (B) AND ALIGN LARGE HOLE ON RIGHT SIDE PANEL (E) WITH TOWEL BAR (K). INSERT CAM-LOCKS (10) INTO LARGE HOLES ON UNDERSIDE OF FIXED SHELF (B) WITH SLOT FOR SCREWDRIVER FACING OUTWARD. ROTATE CAM-LOCKS (10) CLOCKWISE TO SECURE CAM-BOLTS (9). PUSH LARGE COVERS (11) INTO CAM-LOCKS (10). AS FIGURE 1 AND INSET SHOWN.
4. INSERT WOOD DOWELS (2) INTO PREDRILLED HOLES ON UNDERSIDE OF TOP (A) AND FIT INTO TOP EDGES OF UPPER CROSS BRACE, LEFT AND RIGHT SIDE PANELS (I, D, E). INSERT T-BOLTS (12) INTO HOLES NEAR TOP EDGES OF INSIDE OF LEFT AND RIGHT SIDE PANELS (D, E) WITH SLOT FOR SCREWDRIVER FACING OUTWARD. INSERT LONG MACHINE SCREWS (13) THROUGH LOCK WASHERS (14), TOP (A) AND TIGHTEN INTO T-BOLTS (12). PLEASE NOTE THAT IF SCREWS DO NOT TIGHTEN, ROTATE T-BOLTS (12) SO THAT THREADS OF T-BOLTS (12) FACING LONG MACHINE SCREWS (13). PUSH SMALL COVERS (15) INTO THE HOLES ON TOP (A). AS FIGURE 2 SHOWN.
5. ATTACH BACK PANEL (H) INTO SLOTS OF PARTS (D, E, I, J). INSERT PAN HEAD WOOD SCREWS (5) THROUGH PREDRILLED HOLES ON BACK PANEL (H) AND TIGHTEN INTO REAR EDGES OF PARTS (D, E, I, J). AS FIGURE 3 SHOWN.

FIGURE 1

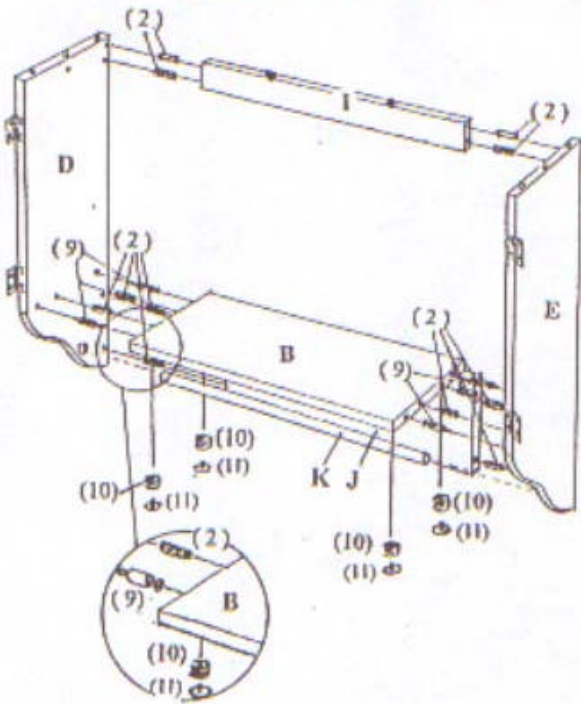

FIGURE 2

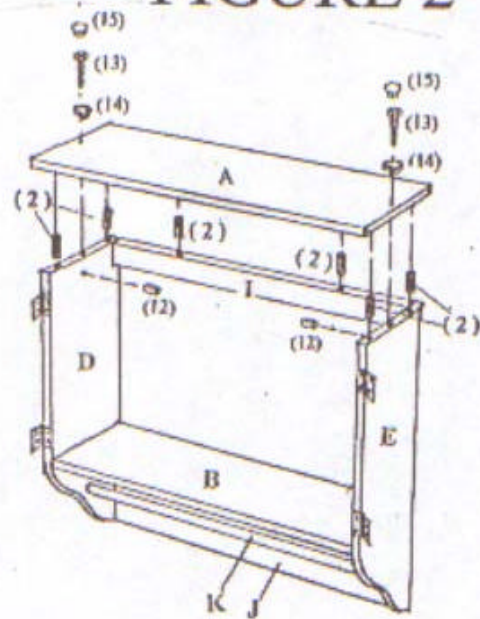

FIGURE 3

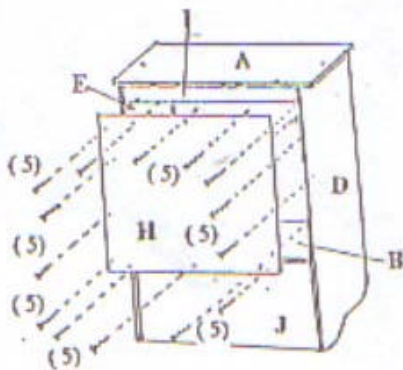

FIGURE 3

FIGURE 4

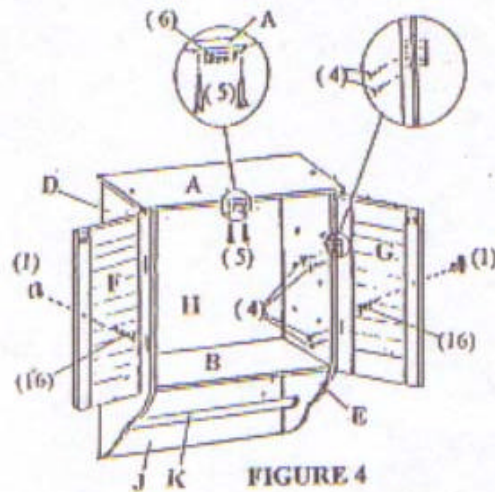

FIGURE 4

6. INSERT PAN HEAD WOOD SCREWS (5) THROUGH ENDS OF MAGNET (6) AND TIGHTEN INTO PREDRILLED HOLES ON UNDERSIDE OF TOP (A). INSERT SMALL FLAT HEAD WOOD SCREWS (4) THROUGH HINGES OF LEFT AND RIGHT SIDE PANELS (D, E) AND TIGHTEN INTO PREDRILLED HOLES ON BACK OF LEFT AND RIGHT DOORS (F, G). INSERT SHORT MACHINE SCREWS (16) THROUGH BACK OF LEFT AND RIGHT DOORS (F, G) AND TIGHTEN INTO METAL KNOBS (1). AS FIGURE 4 AND INSET SHOWN.

FIGURE 5

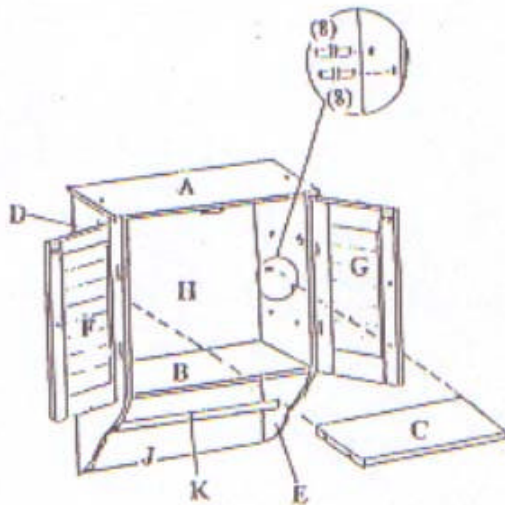
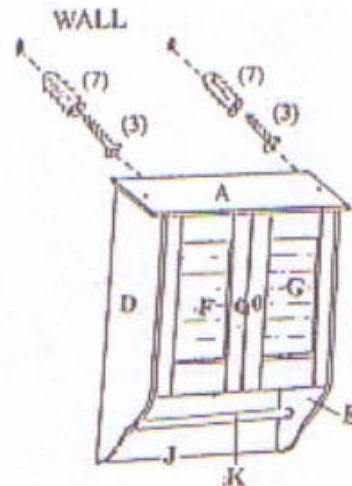

FIGURE 6



7. FIT SHELF SUPPORTS (8) INTO PREDRILLED HOLES ON INSIDE OF LEFT AND RIGHT SIDE PANELS (D, E). PUT ADJUSTABLE SHELF (C) ON EACH SHELF SUPPORT (8) MATCHING THE POSITION OF GROOVES ON ADJUSTABLE SHELF (C). AS FIGURE 5 AND INSET SHOWN.
8. DRILL TWO 1/4" DIAMETER HOLES ON WALL, THE DISTANCE BETWEEN TWO HOLES SHOULD MATCH TO THE HANGING HOLES ON BACK OF THE UNIT. FIT PLASTIC ANCHORS (7) INTO THE HOLES ON WALL; USE SCREWDRIVER TO FIT LARGE FLAT HEAD WOOD SCREWS (3) INTO PLASTIC ANCHORS (7). PUT THE UNIT MOUNTED ON WALL WITH HANGING HOLES TO LARGE FLAT HEAD WOOD SCREWS (3). AS FIGURE 6 SHOWN.

YOUR NEW NASSAU WALL TOWEL CABINET IS FINISHED AND READY TO USE.

Please count, identify and compare parts and hardware list to be sure all parts are present. Extra hardware may be included. If any items are missing, please contact our parts/ service department at (800) 633-5096 or in Dallas (972) 869-0111/ 9am-4pm Mon-Fri central time. Missing or damaged hardware and/ or parts will be replaced free of charge. WE DO NOT SELL PARTS.

WE DO NOT RECOMMEND MODIFYING PRODUCT(S) AND WE ARE NOT RESPONSIBLE FOR ANY DAMAGES DUE TO PRODUCT MODIFICATION(S).

PARTS REPLACEMENT FORM

WHITE STYLE NO: **BE7182**
NATURAL STYLE NO: **BE7582**

Customer Name _____

PARTS
LETTER

PART
DESCRIPTION

QUANTITY
NEEDED

Street, City, State, Zip _____

Phone# _____



Please indicate where you purchased this item.
Store/website/catalog

SOUTHERN ENTERPRISES INC.
P.O. Box 59996 Dallas, Texas 75229

Please indicate color/size/style number

/ /