



SOUTHERN ENTERPRISES INC.







NOTE... This product has been engineered for easy assembly and constructed for durability. Now please take time to read through and follow assembly instructions.



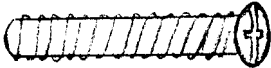

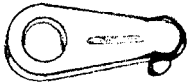
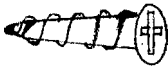
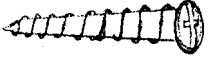
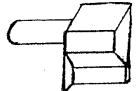
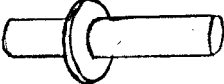

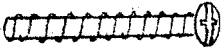
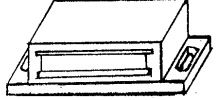

CARVED CURIO CABINET

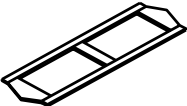
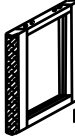
STYLE NO.

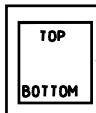
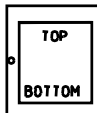
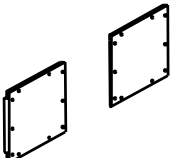
BE0664A/B CHERRY

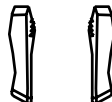
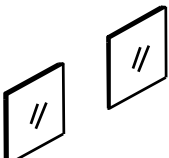
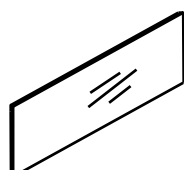
BE0665A/B OAK

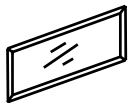
| HARDWARE LIST              |  |                           |   |
|----------------------------|--|---------------------------|---|
| 1                          |     | 2                         |      |
| LARGE PHILIP BOLT<br>12PCS |  | WASHER<br>8PCS            |   |
| 3                          |    | 4                         |    |
| GLASS LATCH<br>16PCS       |  | SMALL WOOD SCREW<br>16PCS |   |
| 5                          |   | 6                         |    |
| LARGE WOOD SCREW<br>26PCS  |  | GLASS SUPPORT<br>4PCS     |   |
| 7                          |  | 8                         |  |
| DOOR PLUG<br>4PCS          |  | LARGE WOOD PLUG<br>8PCS   |   |
| 9                          |   | 10                        |    |
| KNOB<br>2PCS               |  | SMALL PHILIP BOLT<br>2PCS |   |
| 11                         |  | 12                        |  |
| DOOR LATCH<br>1PCS         |  | PLASTIC WASHER<br>2PCS    |   |
| 13                         |   |                           |   |
| SMALL WOOD PLUG<br>4PCS    |  |                           |   |

|                   |   |   |   |   |  |  |   |
|-------------------|---|---|---|---|--|--|---|
| <b>PARTS LIST</b> | A   |  | B   |  <br>LBFT FRONT      RIGHT FRONT<br>RBAR  | C  |  <br>LBFT TOP BOTTOM      RIGHT TOP BOTTOM |   |
|                   |   | TOP-PANBL - WOOD FRAMB<br>1PC   |   | SIDB PANBL - WOOD FRAMB<br>2PCS   |  | DOOR PANBL - WOOD FRAMB<br>2PCS  |   |
| D                 |    |   | F   |  <br>LBFT      RIGHT<br>OUTBR      OUTBR<br>SIDB ON      SIDB ON<br>LBFT      RIGHT | G  |   |   |
|                   | BACK PANBL<br>2PCS  |   |   | LBGS-NO CARVBD<br>2PCS  |  | CARVBD-LBGS<br>2PCS  |   |
| H                 |    | I   |    | J   |  | K  |  |
|                   | BACK MIRROR<br>2PCS   |   | GLASS SHBLF<br>1PC  |   | DOOR FRAMB-GLASS<br>2PCS   |  | SIDB FRAMB-GLASS<br>2PCS  |
| L                 |  | M   |  |   |  |  |   |
|                   | TOP FRAMB-GLASS<br>2PCS   |   | WOOD BRACB<br>1PC   |   |  |  |   |

Please count, identify and compare parts and hardware list to be sure all parts are present. You will also need a Phillips screwdriver, which is not included. Extra hardware may be included. If any items are missing, please contact our parts/ service department at (800) 633-5096 or in Dallas (972) 869-0111. Missing or damaged hardware and/ or parts will be replaced free of charge.

|   |  |             |          |
|---|--|-------------|----------|
| Style No. BE0664 CHERRY<br>BE0665 OAK   | <b>PARTS REPLACEMENT FORM</b>                  |             |          |
| Customer Name   | PARTS  | PART        | QUANTITY |
| .....   | LETTER   | DESCRIPTION | NEEDED   |
| Street, City, State, Zip  | .....  | .....       | .....    |
| .....   | .....  | .....       | .....    |
| .....   | .....  | .....       | .....    |
|  | Please indicate where you purchased this item. |             |          |
| SOUTHERN ENTERPRISES INC.   | .....  |             |          |
| P.O. Box 59996 Dallas, Texas 75229  | Please indicate color/ size/ style number.     |             |          |
|   | ...../...../.....                              |             |          |

# ASSEMBLY INSTRUCTION

**STEP 1.** ATTACH SIDE PANEL – WOOD FRAME (B), INSERT SMALL WOOD SCREW (4) THROUGH GLASS LATCH (3) INTO SIDE PANEL – WOOD FRAME (B), THEN INSERT LARGE WOOD PLUG (8) TO THE TOP & BOTTOM OF SIDE PANEL – WOOD FRAME (B). ATTACHED DOOR PANEL – WOOD FRAME (C), INSERT SMALL WOOD SCREW (4) THROUGH GLASS LATCH (3) INTO DOOR PANEL – WOOD FRAME (C), THEN INSERT SMALL PHILLIP BOLT (10) THROUGH DOOR FRAME INTO KNOB (9) AND TIGHTEN. THEN INSERT DOOR PLUG (7) THROUGH PLASTIC WASH (12) INTO THE DOOR PANEL – WOOD FRAME (C). PLS SEE FIG #1.

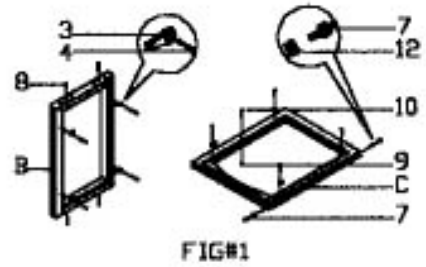

**STEP 2.** ATTACH BOTTOM PANEL (E) AND LEGS – NO CARVED & CARVED (F) (G), INSERT LARGE PHILLIP BOLT (1) THROUGH WASHER (2) AND BOTTOM PANEL (E) INTO THE LEGS (F) & (G). THEN ATTACH SIDE PANEL – WOOD FRAME (B), SCREW BOTTOM FRAME (B) & SIDE PANEL – WOOD FRAME (B) W/ LARGE PHILLIP BOLT (1) AND WASHER (2). PLS SEE FIG #2.

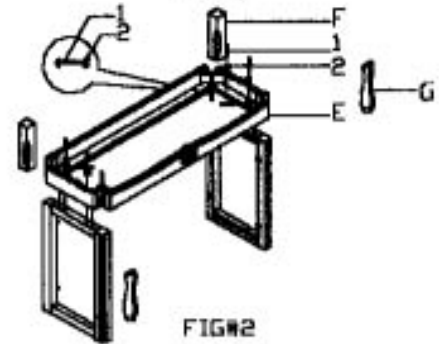

**STEP 3.** ATTACH WOOD BRACE (M), INSERT SMALL WOOD PLUG (13) TO THE BOTH SIDE OF WOOD BRACE (M). INSERT WOOD BRACE (M) TO THE BACK OF BOTTOM PANEL (E) AND MAKE TIGHTEN, THEN ATTACH DOOR PANEL – WOOD FRAME (C), INSERT DOOR PANEL (C) TO THE BOTTOM FRAME (E). ATTACH TOP – PANEL – WOOD FRAME (A), SCREW TOP – PANEL – WOOD FRAME (A) AND SIDE PANEL – WOOD FRAME (B) W/ LARGE PHILLIP BOLT (1) AND ASSEMBLE WOOD BRACE (M) AT THE SAME TIME, MAKE IT TIGHTEN. PLS SEE FIG #3.

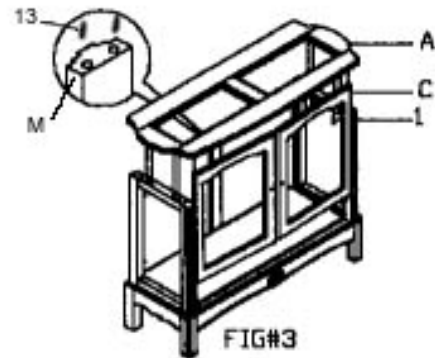

**STEP 4.** LAY DOWN THE CABINET AS SHOWN, LET THE BACK SIDE UPWARD AS FIG #4. PUT BACK MIRROR (H) TO POSITION, THEN PUT BACK PANEL (D) UNDER IT. SCREW BACK PANEL (D) AND CABINET W/ LARGE WOOD SCREW (5), TIGHTEN IT CAREFULLY.

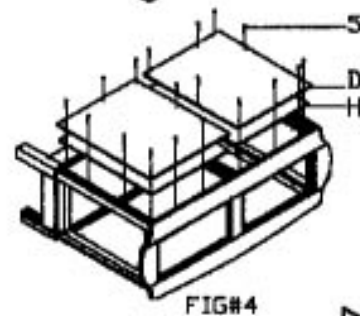

**STEP 5.** STAND THE CURIO CABINET UPWARD AS FIG #5. ATTACH DOOR LATCH (11), SCREW DOOR LATCH (11) AND TOP – PANEL – WOOD FRAME (A) W/ LARGE WOOD SCREW (5). INSERT GLASS SUPPORT TO THE INSIDE OF BOTTOM PANEL (E). PUT TOP FRAME – GLASS (L) ONTO TOP PANEL - WOOD FRAME (A). ATTACH DOOR FRAME – GLASS (J) INTO DOOR PANEL – WOOD FRAME (C) AND SECURE GLASS BY LATCHES. ATTACH SIDE FRAME – GLASS (K) INTO SIDE PANEL – WOOD FRAME (B) AND SECURE GLASS BY LATCHES. PUT GLASS SHELF (I) ON TOP GLASS SUPPORT (6).

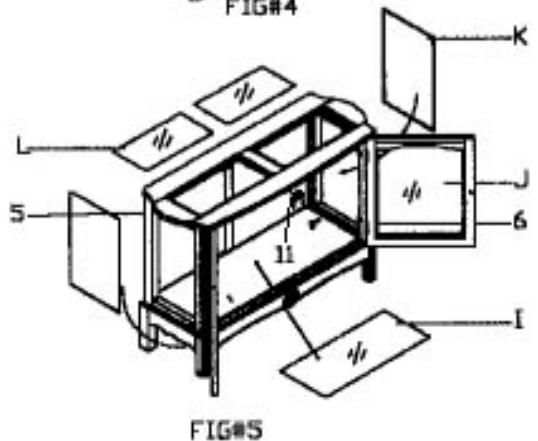

***YOUR BEAUTIFUL CARVED  
CURIO CABINET IS FINISHED AND  
READY TO USE.***



SOUTHERN ENTERPRISES, INC

P.O. Box 59996 Dallas, Texas 75229

THIS PRODUCT IS NOT INTENDED FOR COMMERCIAL USE.