











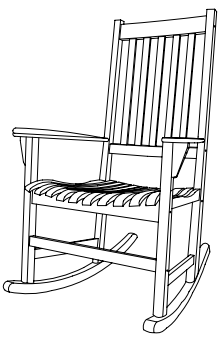
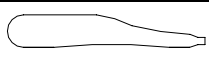
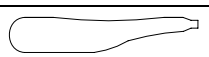
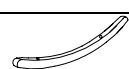
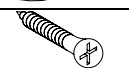

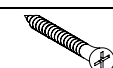
**SOUTHERN ENTERPRISES INC.**

NOTE.... This product has been engineered for easy assembly and constructed for durability. Please take time to read and follow assembly instructions.

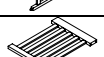
ITEM	DESC	Color
BC6626	Rocking Chair	Ant. White
BC6627	Rocking Chair	Dist Black

**Assembly Instruction**

				PARTS AND HARDWARE LIST			
				No.	Description	Q' ty	Sketch
				F	Left Arm	1	
				G	Right Arm	1	
				H	Runner	2	
				1	Short Wood Screw	2	
				2	Bolt	10	
				3	Long Wood Screw	6	
A	Left Side Frame	1		4	Wood Dowel	14	
B	Right Side Frame	1		5	Allen Wrench	1	
C	Back Frame	1		6	Glue	1	
D	Seat Frame	1					
E	Brace	1					

Please count, identify and compare parts and hardware list to be sure all parts are present. It may help to divide parts and label them to correspond with part list. Extra hardware may be included.

If any items are missing, please contact our parts/service department at (800) 633-5096 or in Dallas (972) 869-0111/ 9am – 4pm Mon-Fri Central time.

Missing or damaged hardware and/ or parts will be replaced free of charge.

**WE DO NOT SELL PARTS. WE DO NOT RECOMMEND MODIFYING PRODUCT (S) AND WE ARE NOT RESPONSIBLE FOR ANY DAMAGES DUE TO PRODUCT MODIFICATION (S).**

If this product has not been purchased from our retail affiliates (within 9 months), we are under no obligation to provide parts or replacement merchandise.

**WE WILL SHIP PARTS IF AVAILABLE. THIS IS NOT A WARRANTY.**

**Parts will not be available for items arriving fully assembled.**

Style No. BC6626  / BC6627

**PARTS REPLACEMENT FORM**

Customer Name \_\_\_\_\_

PARTS LETTER	PARTS DESCRIPTION	QUANTITY NEEDED
-----------------	----------------------	--------------------

Street, City, State, Zip \_\_\_\_\_

_____
_____
_____
_____



SOUTHERN ENTERPRISES INC.  
P.O. Box 59996 Dallas, Texas 75229

Please indicate where you purchased this item.  
Store/ website/ catalog \_\_\_\_\_

Please indicate color/ size/ style number.  
\_\_\_\_\_ / \_\_\_\_\_ / \_\_\_\_\_

## Step 1

Attach the Left Side Frame (A), the Back Frame (C), the Seat Frame (D) & the Brace (E) together with 7 Wood Dowel (4) ,5 Bolts (2) by using the Allen Wrench (5) & Glue(6) as figure shown !

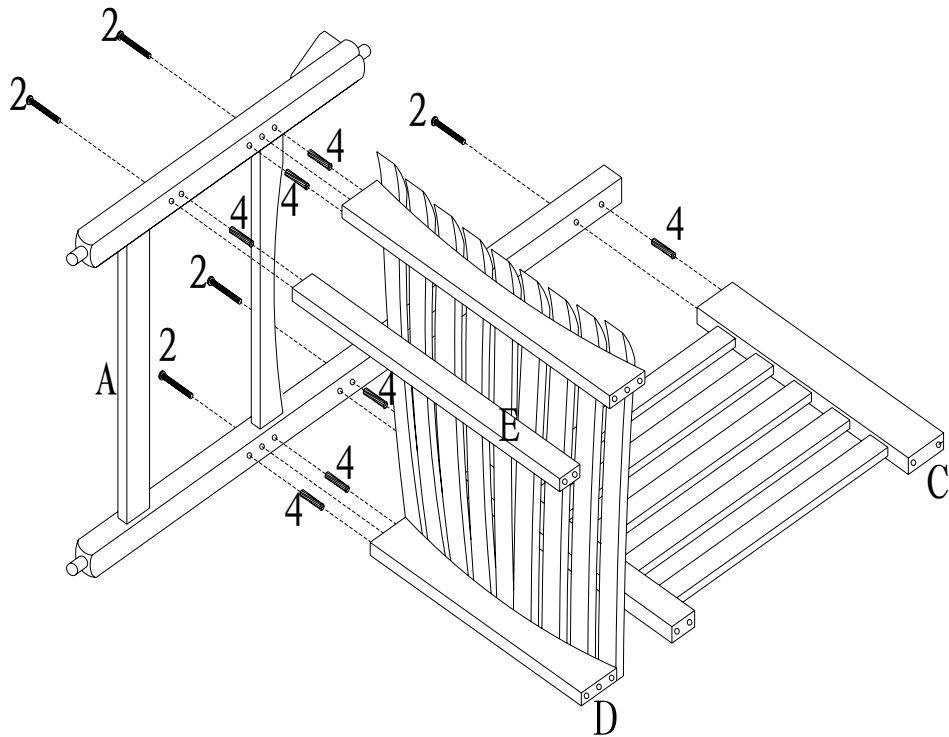

## Step 2

Align the wholes in the Right Side Frame (B) with the corresponding parts assembled on step2, then join them together with 7 Wood Dowel (4) , 5 Bolts (2) by using the Allen Wrench (5) & Glue(6) as figure shown !

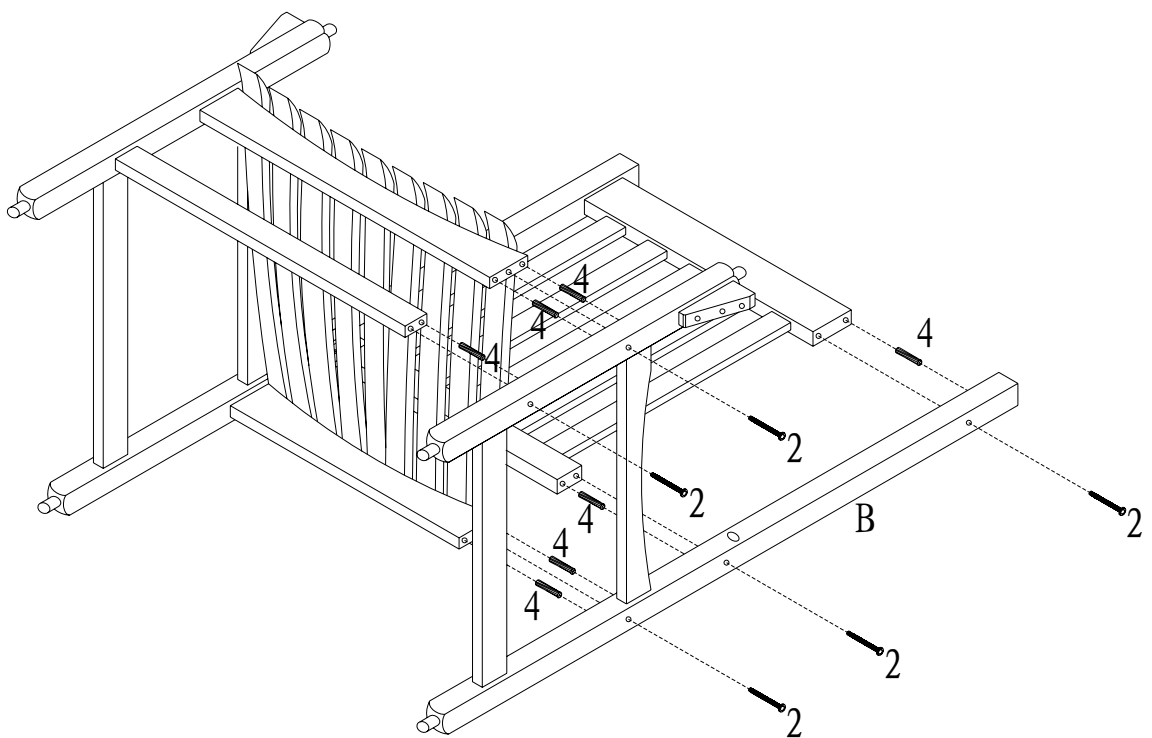

### Step 3

Connect the Left & Right Arms (F,G) & the 2 Runners (H) to the unit assembled on step 2 with 6 Long Screws (3) & 2 Short Screws (2) by using screwdriver as figure shown !

