

8 7 6 5 4 3 2 1

THE INFORMATION CONTAINED IN THIS DRAWING IS THE SOLE PROPERTY OF PREMIER MOUNT DIVISION OF PMPI > ANY REPRODUCTION IN PART OR WHOLE WITHOUT THE WRITTEN PERMISSION OF PREMIER MOUNT DIVISION OF PMPI > IS PROHIBITED.

REVISIONS			
REV.	DESCRIPTION	DATE	APPROVED

(25.46 FULL EXTENSION)

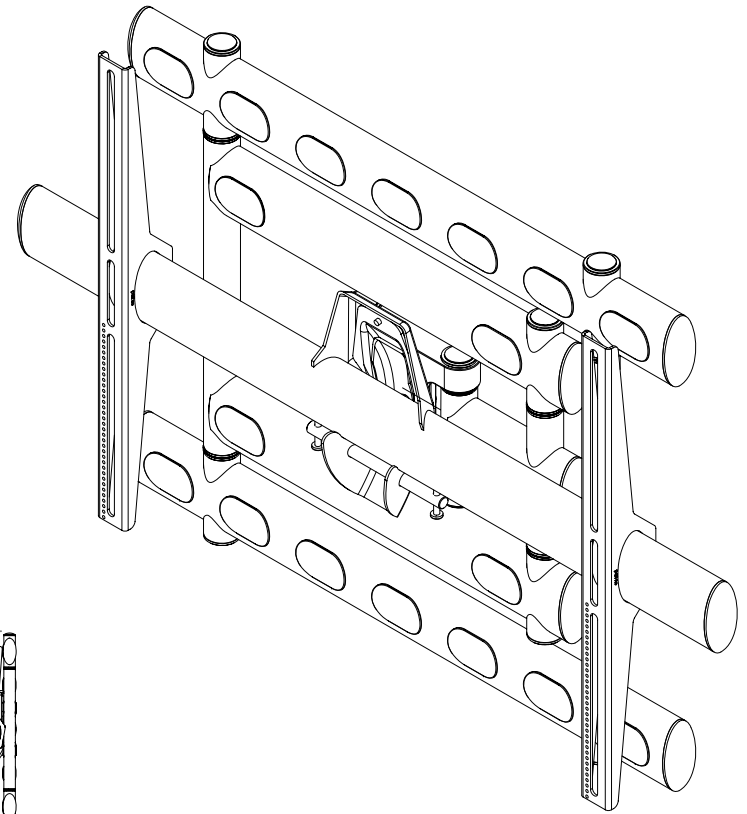
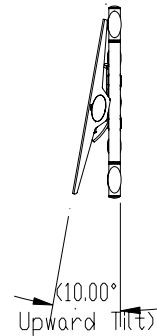
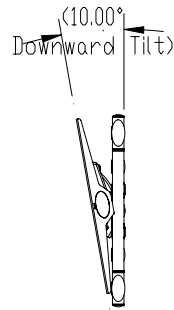
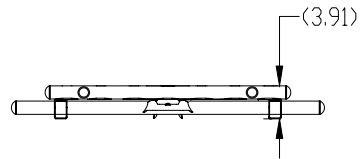
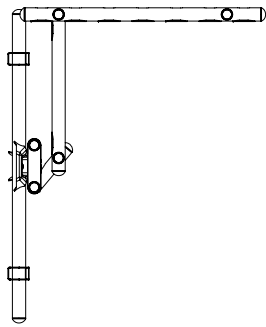
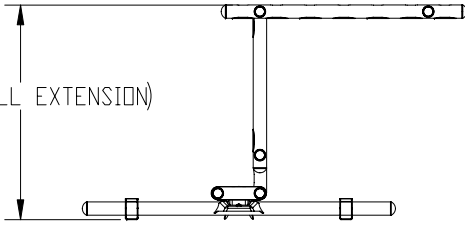

Mounts to 12"-16"-18" and 24" stud centers

Mounting hole covers

Cable Path

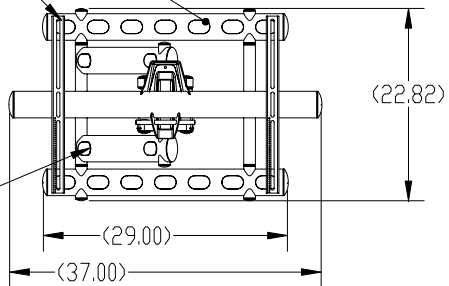

Architectural Specifications

The wall mount will be a Premier Mounts AM3, or equivalent, and can be used to mount plasma, or LCD, displays from a variety of wall structures. It will mount to wood joists, or concrete, and will feature laser cut cable-access ports in the lower and upper mounting rails. It will be made of cold-rolled elliptical steel tubing and will support up to 160lbs. It will be UL listed and approved. Assembly and installation will be performed according to the instructions provided by the manufacturer.

Surface Types - Wood or Concrete

Weight Capacity - 160lbs.

Dimensions - 37.00' (W) x 22.82' (H)

Adjustability - Up to 25.46' from the wall; Tilt Capability of ± 10°

Attachment - Griplates™ and Washers