

Read all instructions before assembly and use of this product.

KEEP INSTRUCTIONS FOR FUTURE USE

INSTRUCTION MANUAL • MANUEL D'INSTRUCTION • EL MANUEL DE LA INSTRUCCION



The Sleigh

Couchette jumelée CO-SLEEPER^{MD}
de ARM'S REACH^{MD}

Cama adosable CO-SLEEPER[®]
de ARM'S REACH[®]

⚠ WARNING: Failure to follow these warnings and instructions could result in serious injury or death. ***THIS UNIT IS NOT INTENDED TO BE USED AS EITHER A FULL OR NON-FULL SIZE CRIB***

⚠ AVERTISSEMENT: Le non-respect de ces avertissements et des instructions peut provoquer des blessures graves, voire mortelles. ***CE PRODUIT N'EST PAS CONÇU POUR SERVIR DE LIT D'ENFANT EN FORMAT STANDARD OU SPÉCIAL***

⚠ ADVERTENCIA: El incumplimiento de estas advertencias e instrucciones puede resultar en lesiones graves o incluso la muerte. ***ESTA UNIDAD NO ESTÁ DESTINADA PARA EL USO COMO SEMICUNA NI CUNA COMPLETA***

List of Parts

- A Bottom of Sleeping Nest
- B Back of Sleeping Nest
- C Bumper Bar —Front Top of Sleeping Nest
- D Front Bottom of Sleeping Nest
- E Right Side Panel with Leg Extensions and Wheels
- F Left Side Panel with Leg Extensions and Wheels
- G Stationary Side Rail
- H Removable Side Rail
- I Allen Key
- J Anchor Plate and Strap Assembly
- K Mattress
- L Bumper Pad
- M Mattress Sheet
- N Screws (20)

Tools required: One Allen wrench key
(Supplied)

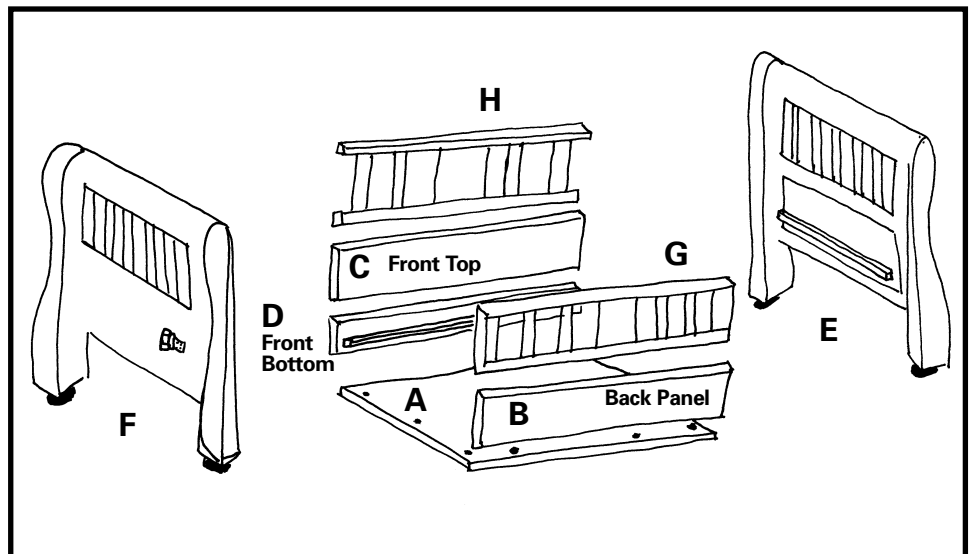

PLEASE NOTE: This product should be assembled in the same room in which the product will be used. Please assemble on a carpet or rug to prevent the wood from being damaged.

NOTE: While one person can assemble this product, it is easier to assemble when two people work together.

KEEP THIS BOOKLET HANDY FOR FUTURE REFERENCE

GARDER CE PETIT LIVRE POUR GUIDE FUTUR

CONSERVE ESTA LIBRO PARA FUTURAS REFERENCIAS

Read all instructions before assembly and use of this product.

⚠️ WARNING: Failure to follow these warnings and instructions could result in serious injury or death. ***THIS UNIT IS NOT INTENDED TO BE USED AS EITHER A FULL OR NON-FULL SIZE CRIB.*** SUFFOCATION HAZARD. Discard all packing materials immediately after opening. Plastic bags and ties may cause suffocation or choking. **Caution: do not discard the anchor plate with the two 10 foot long straps, as this is necessary for using the product in the co-sleeping configuration.**

- NEVER leave child unattended in the Arm's Reach® CO-SLEEPER® bedside sleeper.
- Before assembly, inspect product for damaged hardware, loose joints, missing parts or sharp edges. DO NOT substitute parts.
- WARNING – Never attach the Arm's Reach® CO-SLEEPER® bedside sleeper to your bed without completely assembling all parts.
- WARNING – Always keep caster wheels in the locked position except when moving the unit.
- NEVER USE more than 4-2" (5 CM) extension segments with the Arm's Reach® CO-SLEEPER® bedside sleeper.
- SUFFOCATION HAZARD – Infants can suffocate:
 - In gaps between an extra pad and side of the bassinet / cradle
 - On soft bedding
- NEVER add a mattress, pillow, comforter or padding. Use ONLY the pad provided by the manufacturer.
- DO NOT place infant face down on mattress. Always place the infant on his/her back.
- SUFFOCATION HAZARD – To help prevent suffocation and entrapment, use only the bumper pad and the mattress pad provided by Arm's Reach Concepts, Inc. Never use additional padding or mattress.
- DO NOT use shipping or other bags as mattress covers since they can cause suffocation.
- Use ONLY fitted sheets manufactured for Arm's Reach® CO-SLEEPER® bedside sleeper by Arm's Reach Concepts, Inc.
- STRANGULATION / SUFFOCATION HAZARD: The top edge of the bumper bar/shelf (item C in parts list) must be level with or below the top of the adult mattress when used as a bedside sleeper. The level of the "The Sleigh" Arm's Reach® CO-SLEEPER® bedside sleeper mattress must be a minimum of 4 inches below the top edge of the bumper bar/shelf. NEVER raise the level of the "The Sleigh" Arm's Reach® CO-SLEEPER® bedside sleeper mattress level with, or above the top, of the bumper bar/shelf.
- Be sure to put mattress on top of bumper pad lining.
- NEVER use the Arm's Reach® CO-SLEEPER® bedside sleeper without the anchor plate attached and locked as shown. Failure to use this anchoring system could result in injury or death to the infant. Failure to use this securing system will allow the Arm's Reach® CO-SLEEPER® bedside sleeper to move away from the adult bed and could result in the infant falling out or becoming entrapped. NEVER leave infant unattended in the Arm's Reach® CO-SLEEPER® bedside sleeper.
- STRANGULATION HAZARD: When anchor plate and strap assembly is not in use, store in a safe place not accessible to children.

- Strings can cause strangulation. DO NOT place items with a string around a child's neck, such as hood strings, pacifier cords, etc. DO NOT suspend strings over the Arm's Reach® CO-SLEEPER® bedside sleeper or attach string to toys. DO NOT place product near a window where cords from blinds or drapes may strangle a child.
- WARNING – The removable rail (item H in parts list) should always be installed unless the parent/care giver is in the adult bed and the unit is in the co-sleeping position.
- NEVER leave a child in the unit without the removable rail (item H in parts list) assembled and locked in place. When being used as an attachable Sleigh bedside sleeper the removable rail next to the adult bed should always be installed unless the parent/care giver is in the adult bed and the unit is in the co-sleeping configuration.
- Always check to be sure that the upper locking bars and the lower locking bars are in their "locked position" before placing the infant in the bedside sleeper.
- FALLING HAZARD – To help prevent falls, DO NOT use this product when the infant begins to push up on hands and knees or has reached manufacturer's recommended maximum weight, whichever comes first.
- Discontinue use of the Arm's Reach® CO-SLEEPER® bedside sleeper when child is able to roll over, or pull to a kneeling, sitting or standing position.
- Periodically check your attachable bed to make certain all screws, nuts and bolts are tightened securely.
- Make sure all straps are secured and tight. Check straps before each use.
- If refinishing, use a non-toxic finish specific for children's products.
- Never aim or point a vaporizer or humidifier directly at the product. The water vapor will ruin the finish of the product, as it would any other piece of fine furniture.
- Your Arm's Reach® CO-SLEEPER® bedside sleeper may be cleaned using a damp cloth with a mild soap or a soft dry cloth. Avoid furniture polish or cleaners that may be hazardous to children.
- DO NOT allow children to climb or play on or under the Arm's Reach® CO-SLEEPER® bedside sleeper.
- To avoid injury from pinching, shearing or trauma from falling parts, ONLY an adult should adjust to any of the suggested configurations.
- FALLING HAZARD: Remove infant from the Arm's Reach® CO-SLEEPER® bedside sleeper before starting any conversions.
- Discontinue using your The Sleigh – Arm's Reach® CO-SLEEPER® bedside sleeper should it become damaged or broken.
- WARNING – To prevent serious or fatal injury from falls always keep child within arm's reach. Never leave child unattended.

Assembly

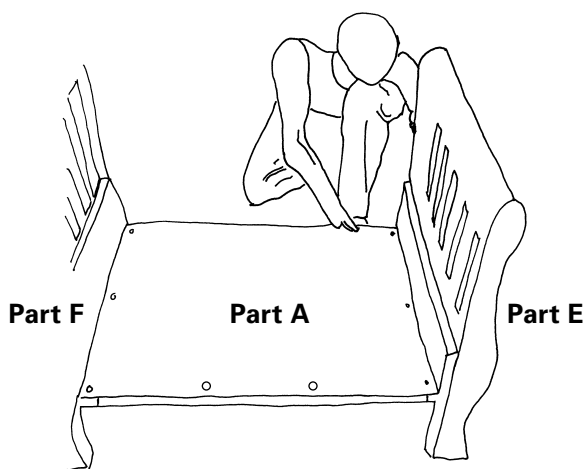

Step 1

Lay bottom of sleeping nest piece (A) on the lip of the right and left side sleigh panels (E) and (F) as shown in fig. 1. Screw into place with the Allen wrench and 3 screws on each side. Make sure the front of the sleeping nest bottom has no screw holes, only the back. The front of the side Arm's Reach® CO-SLEEPER® bedside sleeper panels (E) and (F) have plastic rail connectors for the front removable rail (H). Make sure the sleeping nest bottom front is on the same side as the front of the side panels.

fig. 1

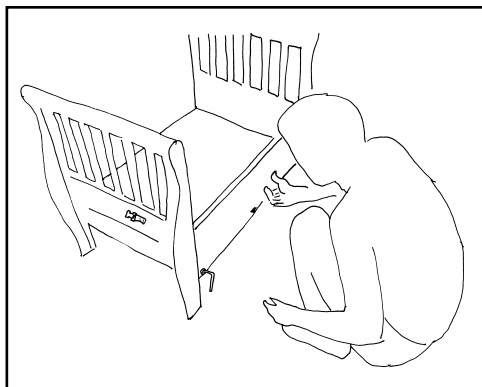

fig. 2

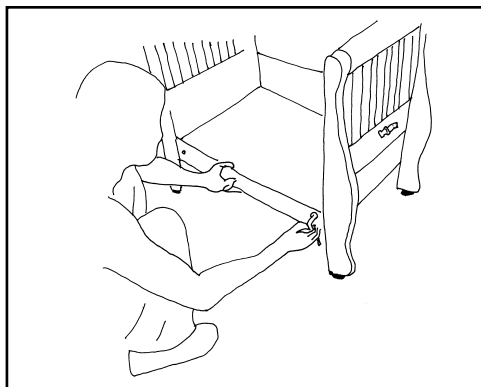

fig. 3

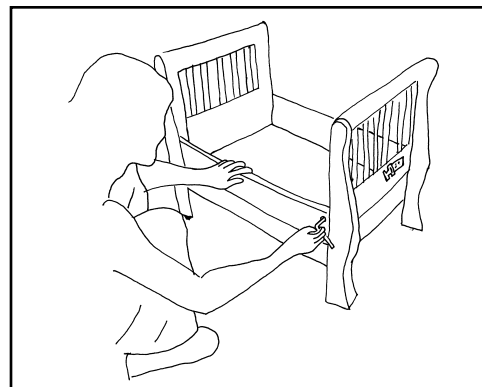

fig. 4

Step 2

Screw on the back of the sleeping nest (B) see fig. 2, 4 screws total, then the front bottom piece (D) fig. 3, then the front top (C) fig. 4.

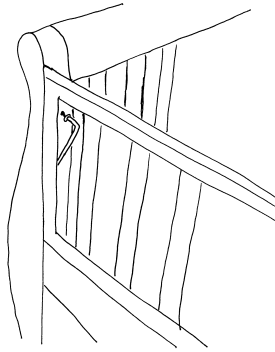

fig. 5

Step 3 - Attaching the front and back rails

Screw the stationary side rail (G) to both side panels (E & F) of the Arm's Reach® CO-SLEEPER® bedside sleeper. See fig. 5. The bumper pad should be placed on the Arm's Reach® CO-SLEEPER® bedside sleeper at this time. See drawing (fig. 5a) for a visual of the placement of the bumper pad. The mattress goes on after the bumper pad is in place and securely fastened to the Arm's Reach® CO-SLEEPER® bedside sleeper.

Be sure to put mattress on top of bumper pad lining.

fig. 5 a

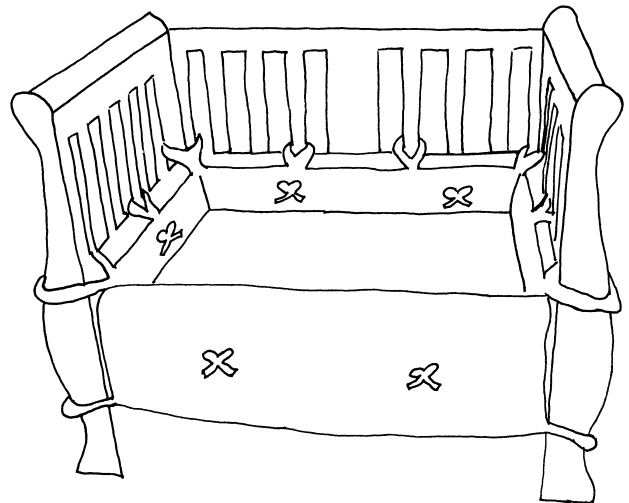

For use as a bedside sleeper go to Step 5

To use the Arm's Reach® CO-SLEEPER® bedside sleeper as a free-standing bassinet: line up the rail with the plastic connectors and snap on the removable side piece. The removable rail should click into place. Make sure the leg extensions are in the lowest position. See fig. 6 for close-up of placement. It is now ready to be used as a baby bed.

fig. 6

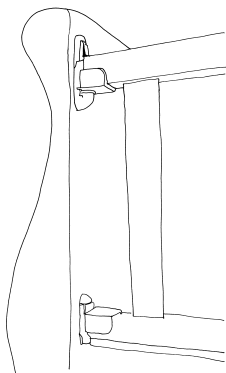

fig. 7

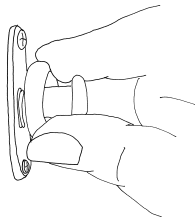
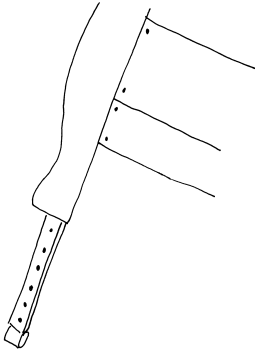

fig. 8



Step 4 – Adjusting the height of *The Sleigh* – Arm's Reach® CO-SLEEPER® bedside sleeper

To make the Arm's Reach® CO-SLEEPER® bedside sleeper panels higher, measure first how much higher you will need to make the Arm's Reach® CO-SLEEPER® bedside sleeper. Lay the bedside sleeper on its side. On the bottom of the legs, find the leg adjuster mechanism. Push down on the white ring while pulling up on the brass knob (fig. 7) and the leg extension will slide out (fig. 8). Do this on all four legs.

Step 5 – Connecting to your bed

See fig. 9 for placement of straps and anchor plate. To secure your Arm's Reach® CO-SLEEPER® bedside sleeper panels to the adult bed, unroll nylon straps from the plastic plate and lay straps across the adult bed to line up with the center of the desired position. The straps must now be positioned between the box spring and mattress. This can be done by sliding the straps using a "sawing" motion and at the same time pulling downward until the straps and anchor plate are in their desired position. One strap should come out on each side of the Arm's Reach® CO-SLEEPER® bedside sleeper panels. Connect the strap connectors to the left and right side of the Arm's Reach® CO-SLEEPER® bedside sleeper panels. Pull the strap taut so the Arm's Reach® CO-SLEEPER® bedside sleeper is tight up against the adult bed.

fig. 9

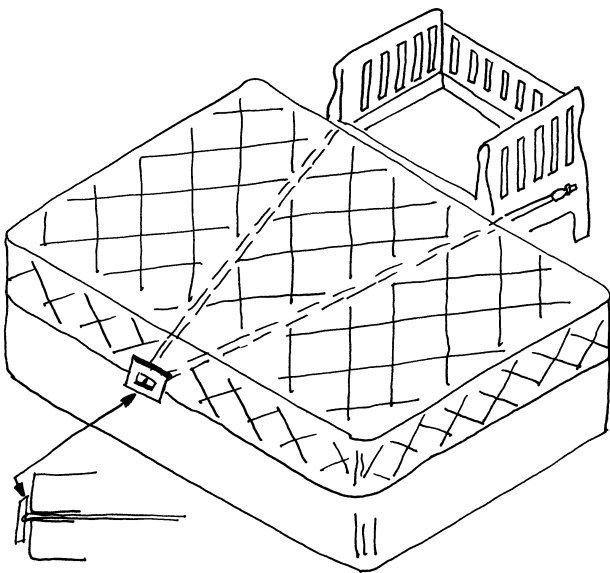

fig. 10



Conversion to the Read-to-Me Love Seat

Take off the bumper pad and the removable rail. Using the Allen wrench, unscrew the top front panel of the sleeping nest. Make sure the leg extensions are in the lowest position.



If you have any questions – call or write Arm's Reach Concepts, Inc.
2081 N Oxnard Blvd., PMB#187, Oxnard, CA 93036-2964
(800) 954-9353 fax: 805-604-7982 www.armsreach.com
Hours: 9:00 A.M. - 4:00 P.M. Pacific Time